

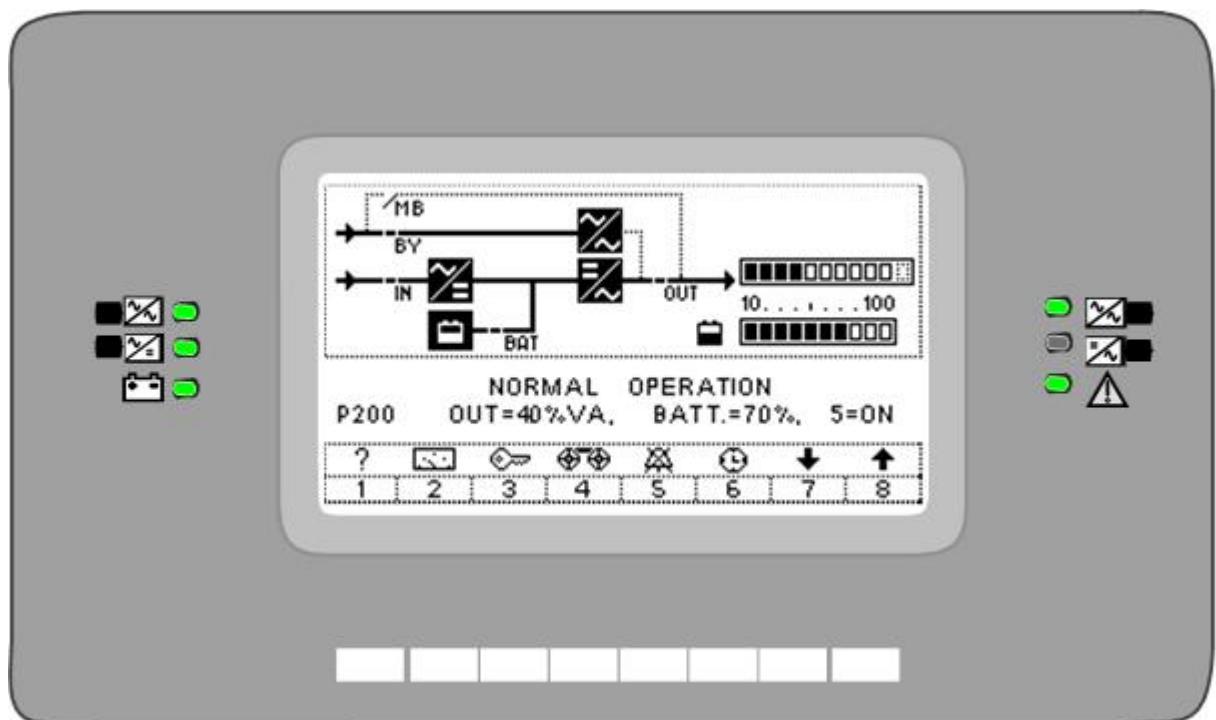

MHT SERIES

DISPLAY AND CONTROL PANEL



USER MANUAL

CONTENTS

I. Display panel functions	4
1.1 General description	4
1.2 Graphic display	7
1.3 Signal messages	10
1.4 Alarm messages.....	10
1.5 Control panel menu	16
1.5.1 Basic menu.....	16
1.5.2 Language setting	19
1.5.3 Measure UPS Threephase version	20
1.5.3.1 Measurements A.....	20
1.5.3.2 Measurements B.....	22
1.5.4 Measure UPS singlephase version	23
1.5.4.1 Measurements A.....	23
1.5.4.2 Measurements B.....	24
1.5.5 Menu key 3 "key", Controls.....	26
1.5.5.1 Keys menu 3, 2 : battery test	26
1.5.5.2 PERSONALIZATIONS.....	28
1.5.5.3 Keys menu 3, 5 : CODE 436215.....	29
1.5.5.4 RATED OUTPUT VOLTAGE.....	30
1.5.5.5 BATTERY.....	30
1.5.5.6 PRE-ALARM.....	33
1.5.5.7 AUTO-OFF "VA".....	36
1.5.5.8 AUTO-OFF Timer.....	37
1.5.5.9 BY-PASS VOLTAGE FIELD	38
1.5.5.10 BY-PASS FREQUENCY FIELD.....	39
1.5.5.11 MODEM.....	39
1.5.5.12 "DIAL /SEND" MODEM.....	41
1.5.5.13 RS232	41
1.5.5.14 ECHO.....	42
1.5.5.15 IDENT.....	42
1.5.5.16 OPERATION IN STANDBY-ON.....	42
1.5.5.17 SMART ACTIVE OPERATION	43
1.5.5.18 INVERTER-OFF/BY-PASS.....	44
1.5.5.19 TOTAL BLOCK.....	44
1.5.6 "RECORDER": RECORDED EVENTS	45
1.5.7 EXCLUDING THE ACOUSTIC ALARM	46
1.5.8 "CLOCK": DATE/TIME.....	46
1.5.9 "ARROW DOWN": INTERNAL CODES.....	47

1. Display panel functions

1.1 General description



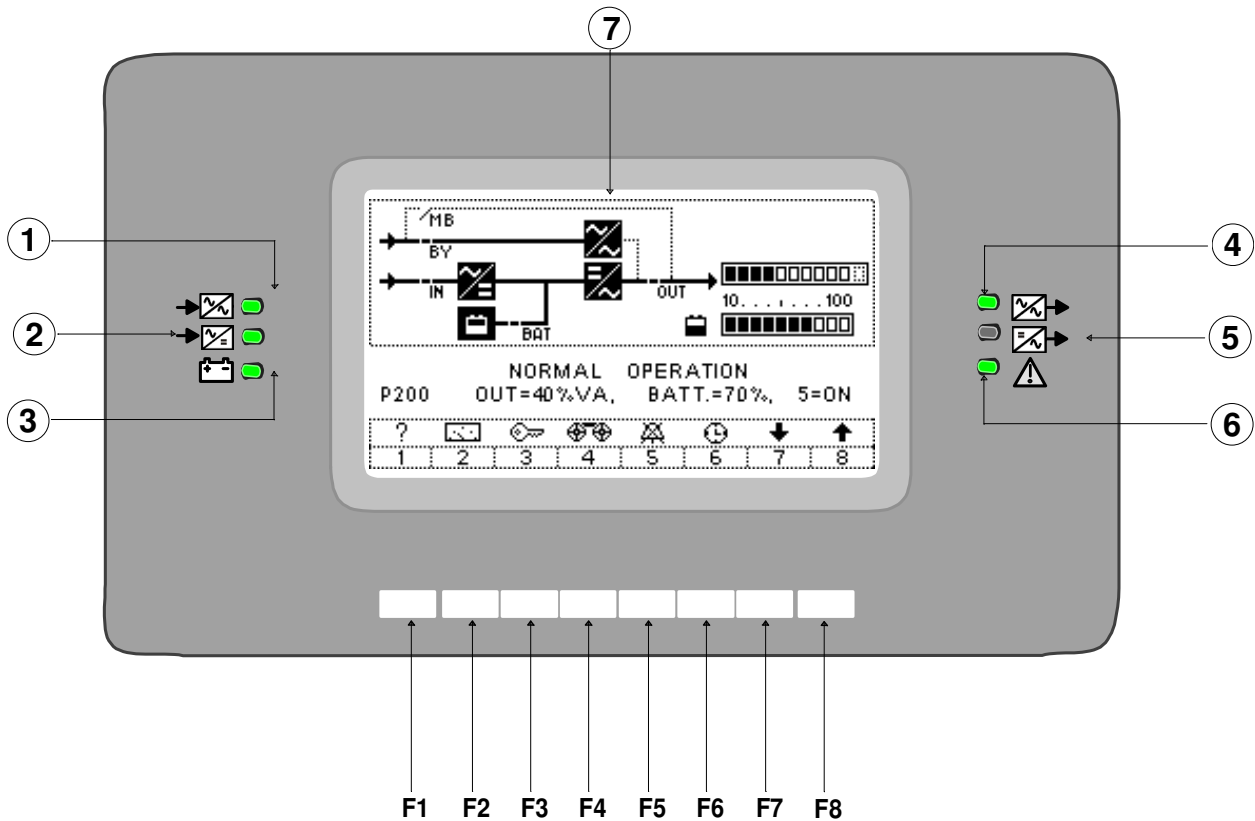

The control panel located at the front of the equipment may be used to monitor and control all the parameters of the UPS and the batteries connected to it. The operating status of the UPS is shown on a liquid crystal display (LCD) with two rows of 40 characters and four LEDs with three operating states: On steady, On flashing, and Off.





①	LED Bypass input line indicator	⑤	LED Normal output
②	LED Mains input line indicator	⑥	LED Alarm for internal fault
③	LED Battery indicator	⑦	Graphic display
④	LED bypass output		

F1, F2, F3, F4, F5, F6, F7, F8: FUNCTION KEYS

The function of each key is shown at the bottom of the display screen and varies according to the menu displayed.

Led status indicators					
Led	Symbol	Color	Function	State	Meaning
1		Green	Bypass line indicator	On	Input Bypass line is present and correct
				Flashing	Input Bypass line is present but not correct
				Off	Input Bypass line is not present. / SWMB closed with all other switches open
2		Green	Mains line indicator	On	Mains is present and correct
				Flashing	Mains is present but not correct
				Off	Mains is not present
3		Yellow	Battery powering the load	On	The battery is supplying the load
				Flashing	The "LOW VOLTAGE ON BATTERY", or "BATTERY DISCHARGE OR SWB OPEN" alarm is active
				Off	The battery is not supplying the load
4		Yellow	Load on bypass	On	The system output is switched onto the automatic bypass line
				Flashing	The system output is switched onto the automatic bypass line with the output power greater than 100%VA, or the manual bypass switch SWMB is closed
				Off	When the system output is switched onto inverter or the output is switched onto the bypass line and both switches SWOUT and SWMB are open, or when the TOTAL BLOCK command is active

- Display and control panel -

5		Green	Normal output	On	The system output is fed from inverter on normal or stand-by operation, the output power is correct since it is less than 100%VA and the output switch SWOUT is closed
				Flashing	The system output is switched onto inverter, the output power is greater than 100%VA, or switch SWMB is closed
				Off	The system output is switched onto automatic bypass, or switch SWOUT is open.
6		Red	Alarm for internal fault	On	An internal fault is present
				Off	There are no internal faults.

All LED are off.

This condition occurs when:

- all switches are open, the UPS is disconnected;
- SWMB closed with SWIN, SWBY and SWOUT open: UPS in maintenance BYPASS.

UPS in maintenance BYPASS.	
	When SWMB closed with SWIN, SWBY and SWOUT open, the display panel will be off. The UPS output terminals will be powered during this operation and all equipment connected will be supplied.

1.2 Graphic display

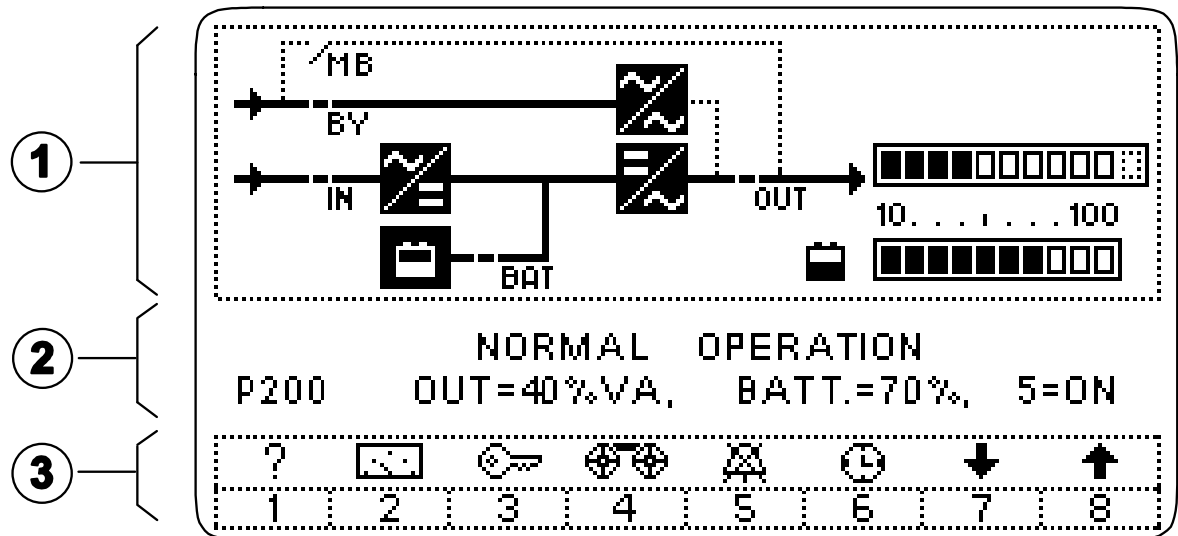

The display is divided into three main areas, each with its own specific focus.

① **Operation Diagram**

Area of the display where the UPS operating status is illustrated by solid lines when they are active and with dotted lines when they are inactive.

② **UPS MESSAGES AND MAIN OPERATING VALUES.**

Area where the UPS operating status is displayed by two lines of text. The first line displays messages that are explained in the “alarm message” section-paragraph. The second line displays the main operating values about the system, output load, battery, buzzer and alarm message number.

③ **KEY FUNCTION**

Area of the display showing the key function numbers and icons. The key function is also indicated in the sub menus, and on the two text lines with the related number. When a key is pressed, the box changes to a solid line to indicate selection

¹⁾ The precision of the measurements is: 1% for voltage measurements, 3% for current measurements, 0.1% for frequency measurements. The indication of residual autonomy time is only an ESTIMATE; it must not, therefore, be considered a precise measuring instrument.

- Display and control panel -

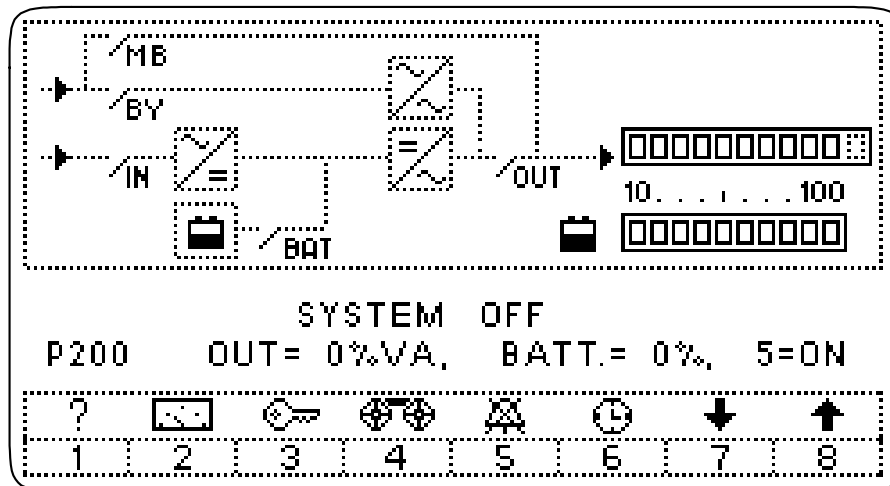

























Table of diagram items		
Active	Inactive	Meaning
		Input converter
		Output inverter
		Bypass line switch
		Battery
		Manual bypass line switch
		Bypass line input switch
		Battery switch
		Output switch
		Main line input switch
		Output load (40%VA or 0%VA)
		Battery(70%Ah or 0%Ah)

- Display and control panel -

Table with key numbers and Icons			
Key Off/ON		Icon	Meaning
		?	Information or n. 1
			Measures or n. 2
			Commands or n. 3
			History or n. 4
			Buzzer OFF/ON or n. 5
			Display date/hours or. n. 6
			Decrease value or sub menu or n. 7
			Increase value or previous menu or n. 8

- Display and control panel -

- acoustic signal.

The acoustic signal sounds intermittently with pauses of approx. 2 seconds, in all conditions other than "NORMAL OPERATION", that is other than the condition in which only the two green LEDs, IN. and OUT., are on. The sound is intermittent without pauses when the BATT. LED is flashing. The acoustic signal can be disabled via key 5, in which case it will never sound. The sound also remains off when the system is deactivated by the AUTO-OFF function. Its state can be seen in the basic menu; "5=ON" indicates that it is enabled and "5=OFF" that it is disabled. It can be disabled via key 5 in all menus where this key does not have other functions, but can only be enabled in the basic menu. The DISABLING IS STORED.

1.3 Signal messages

In normal operating conditions, without special requests for information or insertion of commands through keys or from the remote RS232 line, the LCD display shows some basic messages which are also referred to with the basic menu or NORMAL menu names. Other information can be obtained, or commands inserted, by accessing submenus by pressing keys 1 to 8 in specific sequences. A brief sound is made each time a key is pressed, while the messages will only be changed when an enabled key is pressed. The function of the keys in the Normal menu is shown by associated symbols, while in other submenus this is indicated explicitly by the message. The Normal menu can be accessed by pressing the keys, and is automatically returned to approx. two minutes after the last key is pressed`.

1.4 Alarm messages

Below is a list of the alarm messages that are shown on the first line of the display panel.

DISTURBANCES ON BYPASS LINE

Alarm present when there is interference on the by-pass line, such as voltage peaks or harmonic distortion, while the voltage and frequency are correct. WARNING: in this case the inverter is not synchronized with the by-pass line; if the by-pass is forced with disconnecter SWMB, with the remote commands or from the panel, the load may undergo a sudden variation in voltage.

MANUAL BYPASS, SWMB ON

The manual by-pass disconnecter SWMB is closed, thus preventing the UPS from returning to normal operation. The load is powered directly from the input and will remain unpowered if there is a mains failure.

BYPASS LINE VOLT. FAIL OR SWBY, FSCR OFF

The SENTRY MPS-HP does not recognize the by-pass line because it is outside the acceptance field or because disconnecter SWBY is open,

MAIN LINE VOLTAGE FAIL OR SWIN OFF

The power supply voltage is not correct, the load is powered with the energy stored by the battery. This alarm is present if one of the following conditions occurs:

- the supply voltage or frequency of the rectifier power supply line is not within the acceptance field (see characteristics)
- SWIN is open,
- rectifier fault,

PREALARM, LOW BATTERY VOLTAGE

Alarm present if the residual backup time is lower than the time set for the pre-alarm (the factory-set value is 5 minutes).

LOW BATTERY CHARGE OR CLOSE SWB

A BATTERY TEST performed by the UPS logic with the mains power supply present detected a battery voltage lower than the value calculated (see BATTERY TEST menu page 48).

LOW INPUT VOLTAGE OR OUTPUT OVERLOAD [W]

Alarm present if one of the following conditions occurs:

- the power supply voltage in input is insufficient to power the load (see general characteristics);
- the active power [W] of the output load is greater than the rated value.

OUTPUT OVERLOAD

This indicates that the power absorbed by the load, which is powered by the inverter, is greater than the allowed rated power, thus the value indicated, expressed as a percentage %VA, exceeds the value of 100%. The same alarm is also activated when the peak current absorbed by the load exceeds the maximum value allowed.

When this alarm is present, the load must be reduced otherwise the system will automatically transfer onto the by-pass line within a time that is inversely proportional to the value of the overload.

BYPASS FOR OUTPUT POWER "VA" < AUTO-OFF VALUE

This message is present when the power in %VA absorbed by the load is lower than the "AUTO-OFF" value set (see page 48). The %VA value for AUTO-OFF is factory-set at zero (thus the alarm condition cannot be checked).

INTERNAL FAULT: number

Alarm codes used by the service.

TEMPORARY BY-PASS, WAIT

This indicates that the load is powered from the by-pass line and the system is in the phase prior to the automatic return to normal operation with power supply from the inverter. This temporary operation may take place, as an example, during the start-up phase or while waiting for the return onto inverter after a by-pass due to overload.

BYPASS FOR OUTPUT OVERLOAD

This indicates that the load is powered from the by-pass line and is greater than the rated value; the value indicated on the panel, expressed as a percentage %VA, exceeds the value of 100%.

The load must be reduced so as not to damage the SENTRY MPS-HP.

The load must be reduced in order to return to NORMAL OPERATION. Wait a few minutes to allow cooling (e.g. the time for the return to NORMAL OPERATION is 60s if the load goes down to 50%, and 8 minutes if it goes down to 75%).

BYPASS COMMAND ACTIVE; 8=COM. OFF

Alarm present when the system has been deactivated and switched onto the by-pass, by means of a specific command inserted via the keyboard. The command remains stored also during shutdown due to a power supply failure. The system does not return to normal operation when the power supply is restored if the block has been set intentionally and not deactivated.

REMOTE BYPASS COMMAND ACTIVE 8=OFF

Alarm present when the system has been deactivated and switched onto the by-pass, by the command applied with the "signals and remote commands" connector.

The command is not stored, and the system returns to normal operation when the command is cancelled, provided there is a power supply voltage.

OVERTEMPERATURE or FAN FAILURE

Alarm when one of the internal temperatures on the system card, the inverter power modules, the rectifier power modules or the transformers has exceeded the maximum value allowed.

This may be caused by:

- operation in an environment where the temperature is too high;
- a fault in the fans.

INPUT VOLTAGE SEQUENCE NOT OK

Indicates that the sequence of the phases at the by-pass line input is not correct.

It is normally sufficient to change the two phases over in order to obtain normal operation.

OUTPUT OFF, CLOSE SWOUT OR SWMB

Alarm when there is no output voltage because SWOUT and SWMB are both open at the same time.

BLOCK COMMAND ACTIVE; 8=OFF

Alarm present when the command for total shutdown from the panel or through the RS232 connection, **COMMAND STORED**, has been inserted. The system executes the shutdown command with a few seconds' delay to allow for cancellation. The command remains stored even during shutdown due to a power outage. When the power supply is restored, the system does not return to normal operation if the block that has been intentionally set is not deactivated; to deactivate it close SWBY or, if required, press 8.

REMOTE BLOCKING COMMAND: ACTIVE 8=OFF

As the previous alarm, with command present from the "REMOTE" connector.

MEMORY CHANGED: CODE = number

Code 1 the memory has been changed and the operating parameters have returned to standard values.

If non-standard values were previously set, these must be personalized again.

Switch the display off and then on again in order to remove the alarm.

N.B.: codes other than 1 may be displayed temporarily during variations due to personalization, but this does not affect normal operation.

AUTO-OFF Timer: Toff= 0: 0', Ton= 0: 0'

Alarm when the daily timer set for the control of the automatic shutdown and restart cycles starts operating (page 48). The values of Toff and Ton are factory-set to zero (thus the timer condition is disabled).

1.5 Control panel menu

1.5.1 Basic menu

If no commands have been inserted, the first line of the basic menu shows:

“NORMAL OPERATION” if there are no alarms;

“ xxxxxxxxxxxxxxxxxxxxxxxxxxxx ” if there are alarms, the active ALARM messages are displayed one at a time for a few seconds.

NORMAL OPERATION

_200 OUT=100%VA, BATT= 100%Ah, 5=ON

- Display and control panel -



In each operating condition, the display returns to the "basic menu" after two minutes from the last command inserted with the keys. The basic menu shows the signal messages relating to the current operating state.

The second line of the basic menu shows:

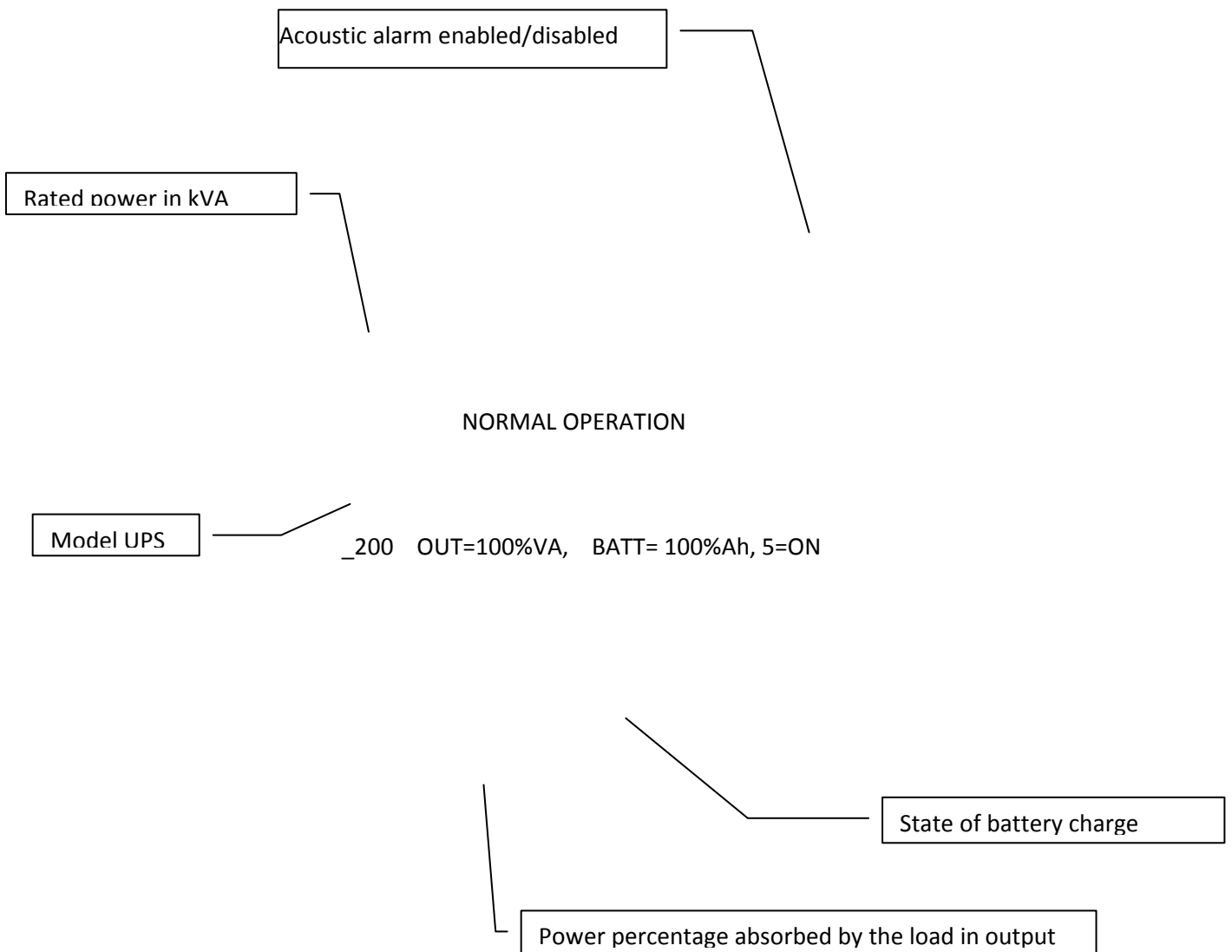

- Display and control panel -

The message OUT changes to BY when the load is not powered from the inverter (normal operation) but from the mains through the by-pass line.

The message OUT=100%VA changes to OUT= SWMB when the load is powered through the maintenance by-pass disconnecter line, and the output current cannot be provided.

The value 100%VA provided in the example is obtained from the measurement of the output current.

The number indicates the output current with the value relating to the absolute rated value and the value indicated is the greater of the effective current and the peak current.

- **BATT= 100%Ah**: example of the current state of the percentage of battery recharge.

The value 100%Ah is obtained from the measurement of the charge current and the time taken to recharge.

The number indicates the recharge value as a percentage according to the capacity of the battery connected and to the quantity of charge used during battery operation.

The system automatically remains in rapid charging for all the time needed to supply the battery with the quantity of charge lost during the discharge.

The indication "%Ah" changes to "min." (minutes) during operation in the event of a mains failure or when the battery is discharging. In this case the numeric value refers to the remaining minutes of operation, calculated according to the current supplied by the battery and to the state of charge of the battery.

N.B.:

The backup time shown is calculated according to the measurement of the discharge current present at that time, the stored value relating to the capacity of the battery connected and the stored value relating to the percentage of recharge prior to discharge. The backup time shown should nevertheless be considered as indicative due to the many different factors affecting it. If considerable differences are noted between the expected value and the actual time of a discharge with constant load, the stored data relating to the battery must be checked, as must the state of the battery.

- **5=ON**: example of the message showing whether or not the acoustic alarm is enabled; if disabled, the message changes to 5=OFF.

1.5.2 Language setting

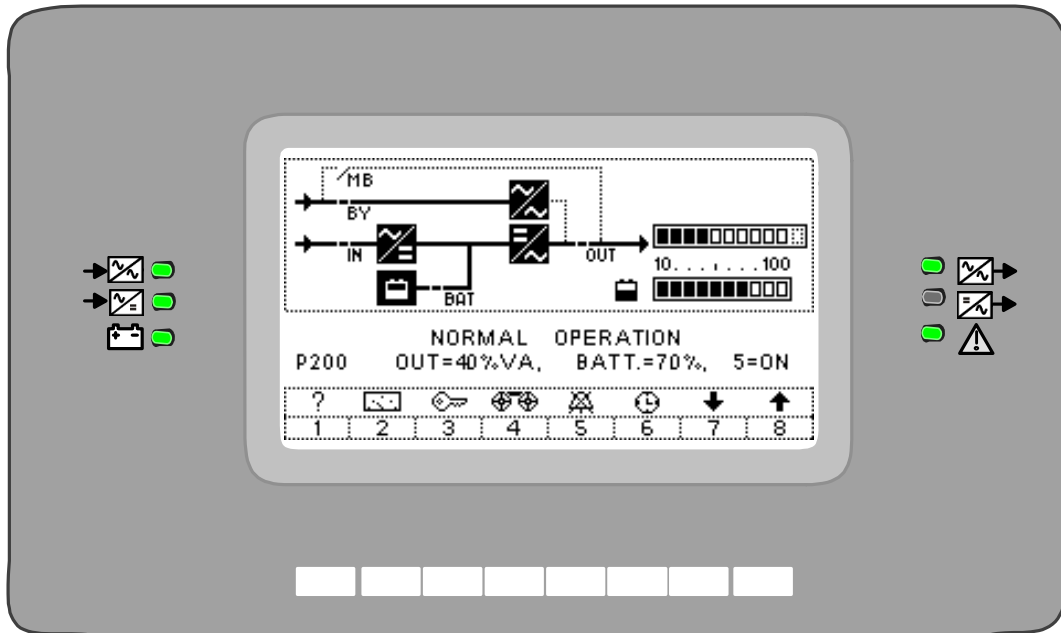

From the keys menu, press **1** twice to access the languages menu.

The following languages are available: Italian, English, French, German, Spanish, Dutch, Swedish, Polish, Hungarian, Turkish, Czech, Russian (optional), Romanian and Portuguese.

The system will show all subsequent messages using the language chosen. The selected language remains stored even after the shutdown and restart of the system. The current language can only be changed by accessing the LANGUAGES menu.

Use keys **1** and **8** to return to the basic menu.

- Display and control panel -

IN = rectifier input line value;

BY = bypass line value;

Bat = battery value (voltage and current);

OUT = UPS output value;

Apk = peak current value;

i = inverter output value;

Vdc = input inverter dc voltage value;

Ts = system temperature value;

- during operation from by-pass, the message OUT

changes to BY;

- battery current, positive with Battery discharging,

negative with battery charging.

1.5.3.2 Measurements B

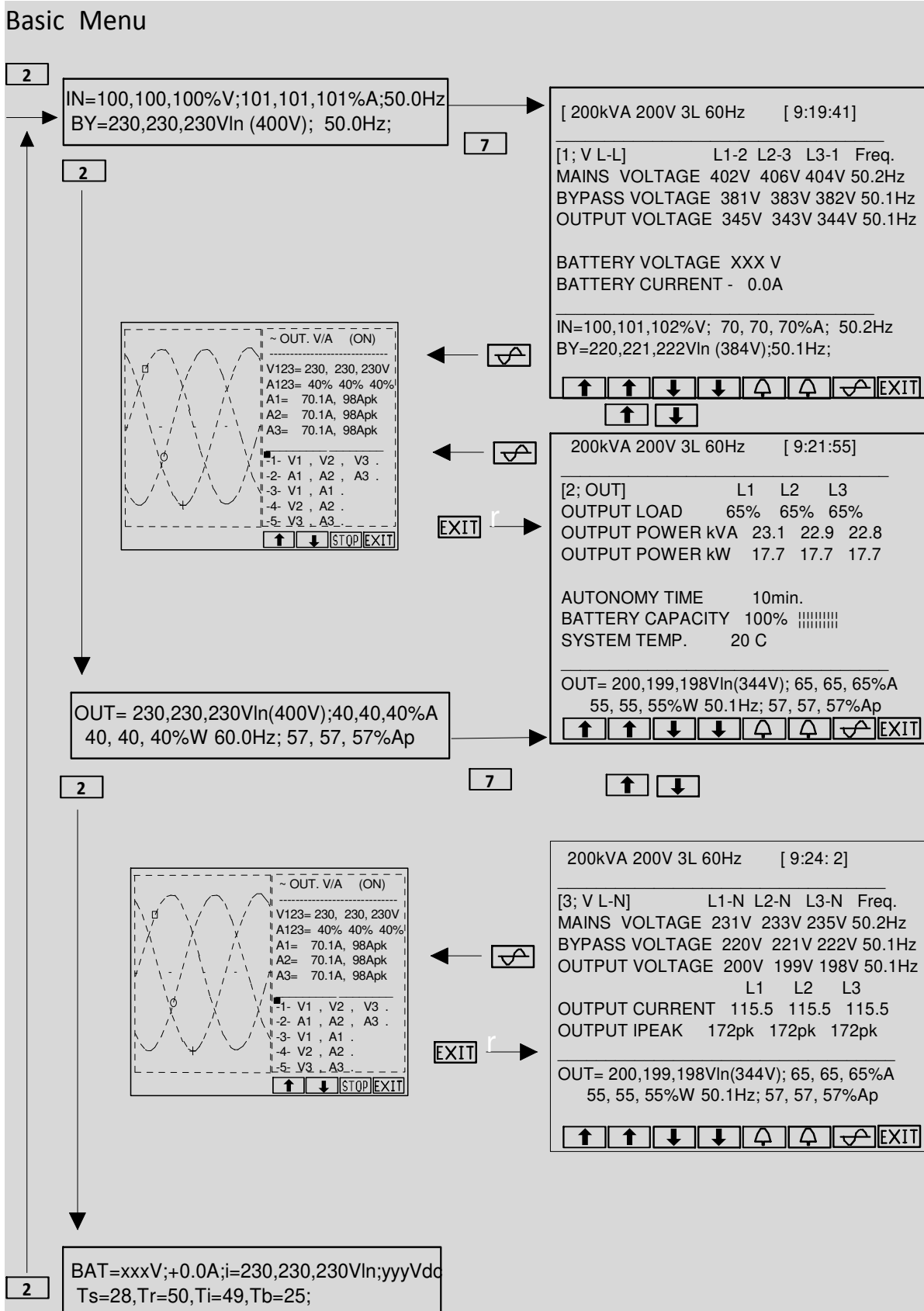

1.5.4 Measure UPS singlephase version

1.5.4.1 Measurements A

	OUT=10000h	hours of normal operation;
The measurements are selected from the basic menu b	BY=10000h	hours of operation from bypass;
pressing key 2	BATT=10000s	time spent in operation from battery;
	nBATT = 1000	number of times the battery has discharged;

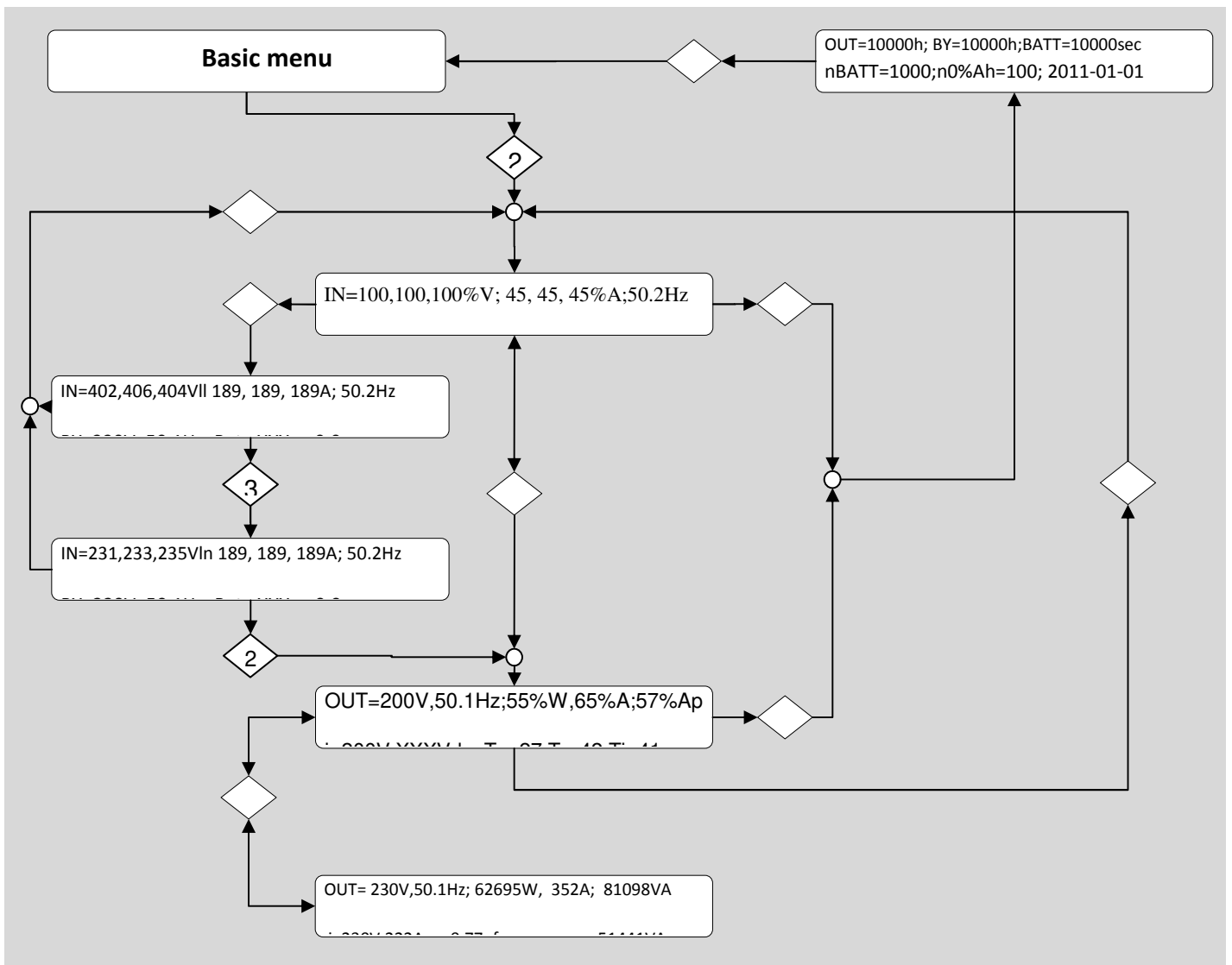

- Display and control panel -

- during operation from by-pass, the message
OUT

changes to BY;

- battery current, positive with Battery
discharging,

negative with battery charging.

IN = rectifier input line value;

BY = bypass single phase line value;

Bat = battery value (voltage and current);

OUT = UPS single phase output value;

Apk = peak current value;

i = inverter single phase output value;

Vdc = input inverter dc voltage value;

Ts = system temperature value;

Tr = rectifier power module temperature
value;

Ti = inverter power module temperature
value;

Tb = battery cabinet temperature value
(optional);

W = Active output power;

VA = output Apparent power;

VAr = output Reactive power;

Pf = output power factor;

1.5.4.2 Measurements B

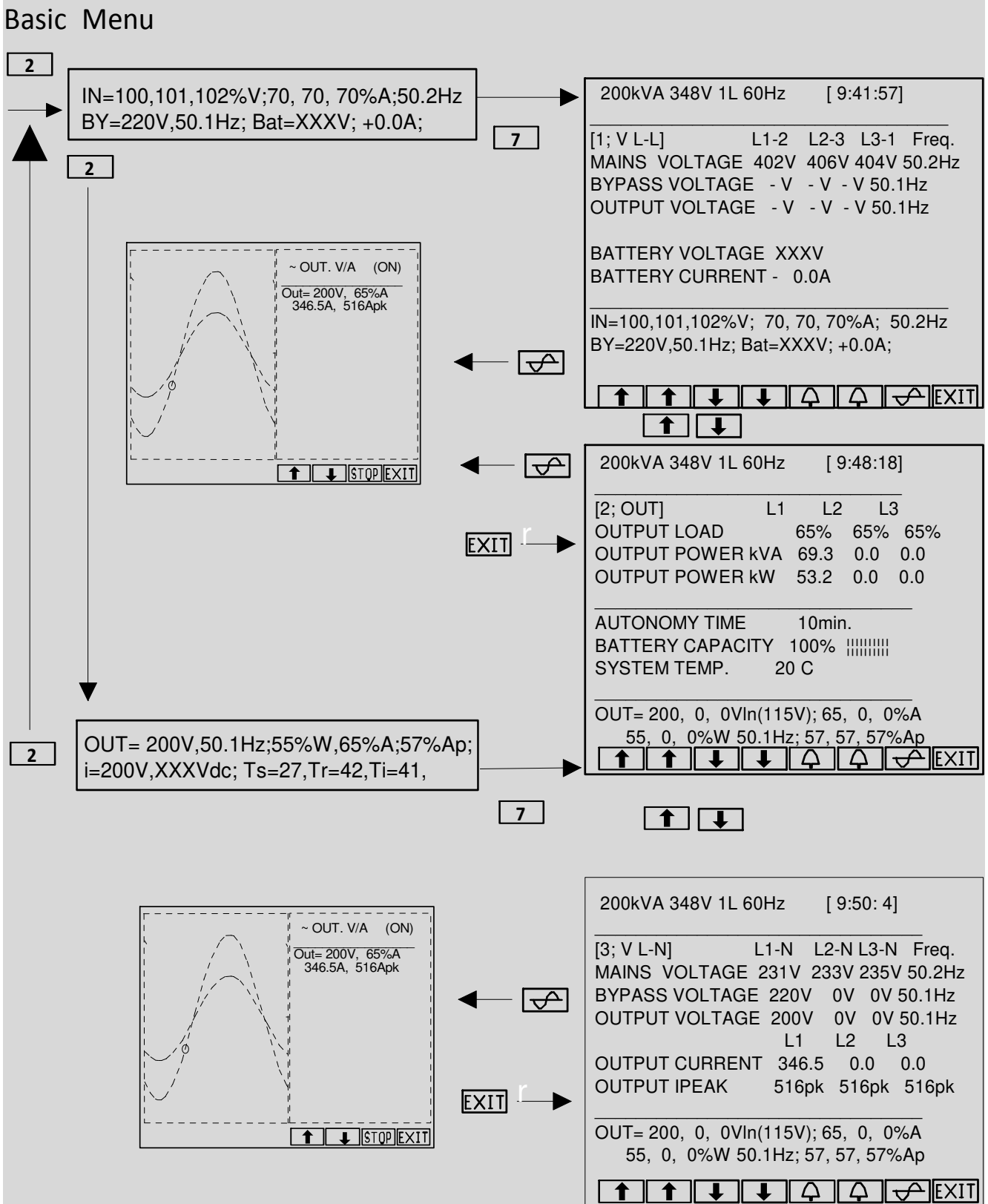

1.5.5 Menu key 3 "key", Controls

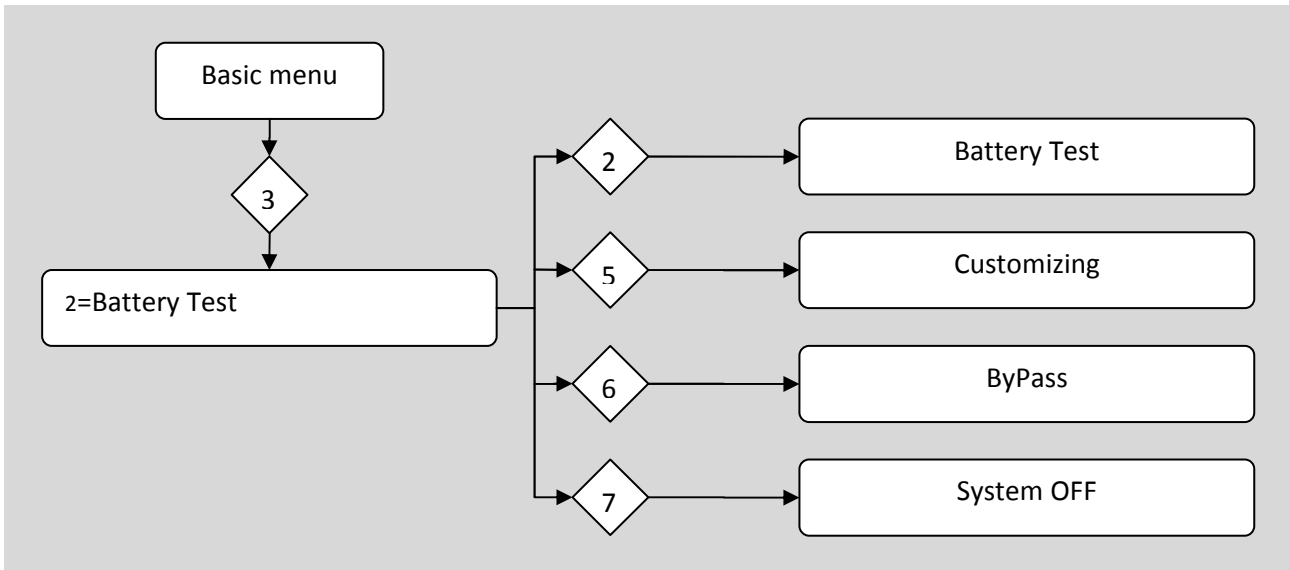

1.5.5.1 Keys menu 3, 2 : battery test

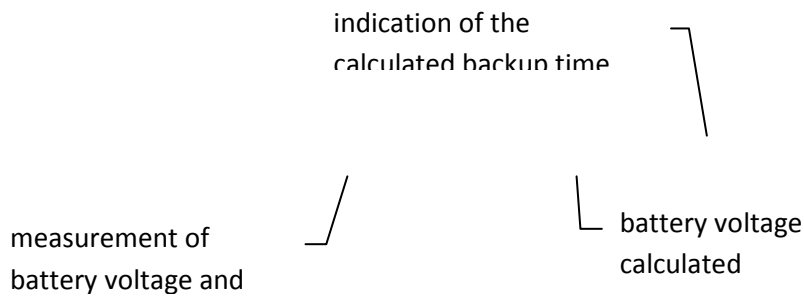
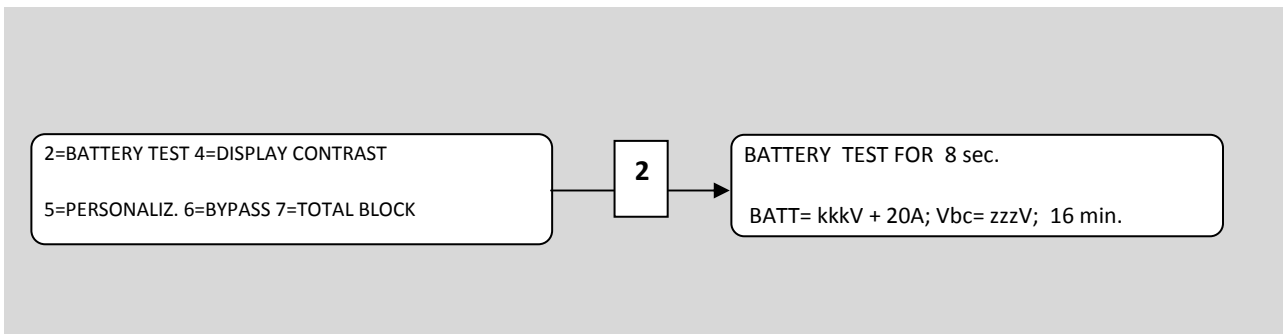

- Display and control panel -

This activates the cycle to check the state of efficiency of the battery, which lasts 8 seconds. Press key 8 to interrupt the test and return to the basic menu before this time has elapsed.

The battery test cycle lowers the rectifier output voltage so that the battery can be evaluated with the real supply on the load even when the power supply voltage is present.

The rectifier output voltage is only lowered if the by-pass line voltage is present, in order to avoid any disruption to the output load without the support of the by-pass.

The battery test cycle is activated:

- manually;
- automatically every 60 sec. after each failed test (for three times), or each time the system is restarted;
- automatically every 24 hours from system start-up;
- automatically in invisible mode during operation without mains power supply.

At the end of each test, the alarm is activated if the voltage measured is lower than the calculated voltage; the charge value stored and the backup time indicated are subsequently halved. A new test is performed 60 sec. after activation of the alarm and if the result is negative the alarm is activated once again for another 60 sec.

The alarms continue to halve the charge value stored until the calculated battery voltage is less than the voltage actually measured. In practice, this battery control system produces an alarm each time the battery is seen to have less than half of the expected charge. If this alarm is on PERMANENT, it indicates that the battery is inefficient, the battery circuit is interrupted, the battery disconnecter has remained open or one of the protection device fuses has been triggered. If this alarm is on TEMPORARY, it indicates a reduction in the efficiency of the battery; the more frequent the alarm, the more serious the problem.

Disabling the BATTERY TEST: press keys 3, 5: "PERSONALIZATIONS", insert code 323232, with battery test disabled the code 0=02 will be shown in the basic menu of the display. To reactivate the test, insert code 323232 again.

- Display and control panel -

1.5.5.2 PERSONALIZATIONS

The "PERSONALIZATIONS" menu is accessed by means of key 5 from the COMMANDS menu, an intermediate menu will then be displayed in which a CODE has to be entered.



Access by CODE ensures that unauthorized persons cannot modify the operating parameters of the equipment.

The use of the codes to modify the operation of the equipment (such as the frequency converter, stabilizer, rectifier start-up delay, etc.) are the prerogative of the service personnel.

The activated codes may be displayed (if present) with the following sequence of keys from the basic menu: 7 + 4 then by scrolling through the alarms with keys 7 and 8.

The following message will be displayed:

System Autorestarting Disabled. = 1

Number of code Code present 1 = code active

Number codes Option= 4.1, (10. active= 1). 8=next Next code, if present

1.5.5.3 Keys menu 3, 5 : CODE 436215

The code is no longer required for 2 minutes after it has previously been inserted.

The next menu can only be accessed by inserting the correct code, otherwise it returns to the basic menu.

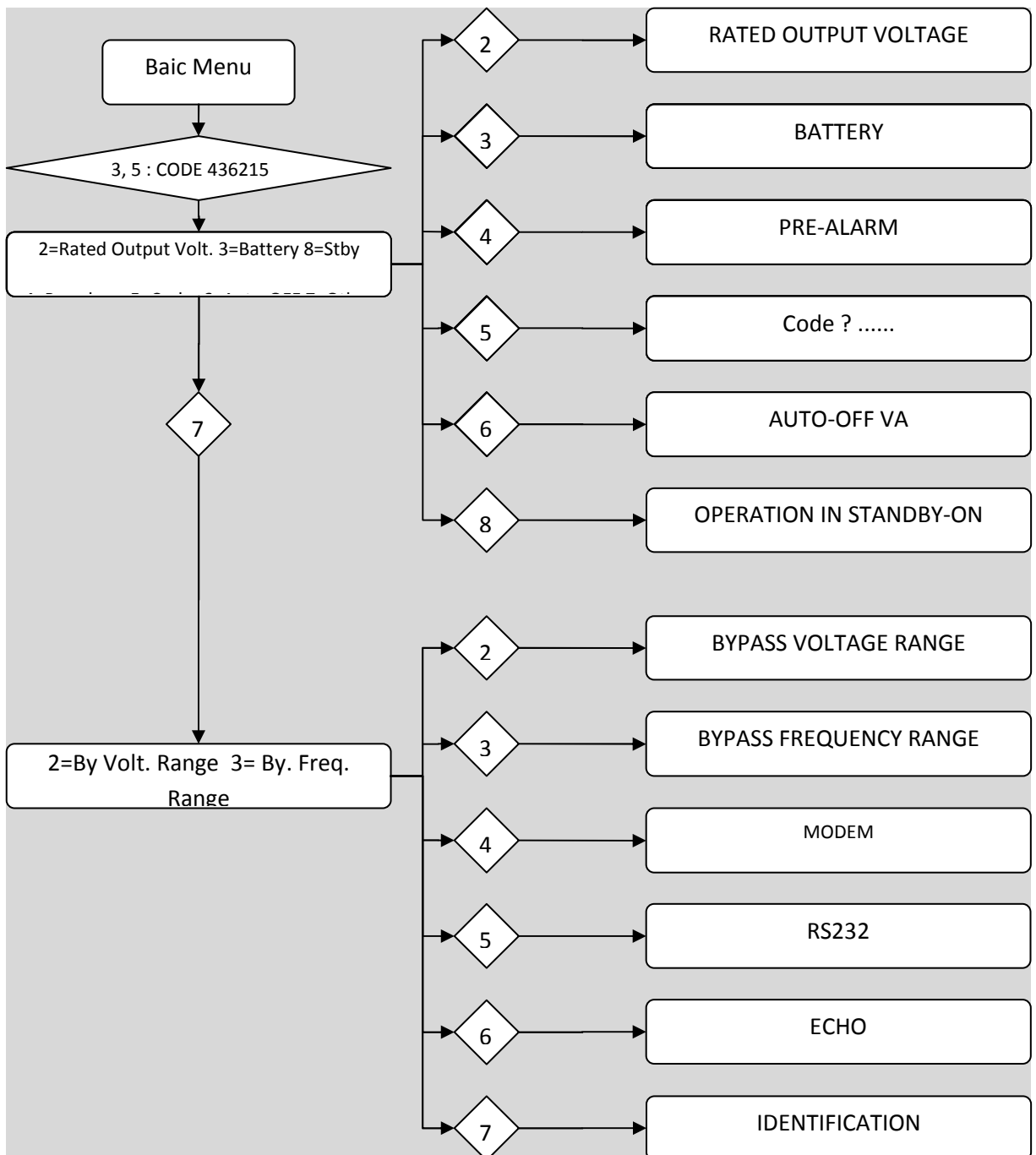

1.5.5.4 RATED OUTPUT VOLTAGE.

Press the following sequence of keys to access the menu: 3, 5, 436215, 2

Keys 7 and 8 can be used to decrease or increase the rated output voltage.

The value displayed is the voltage between phase and neutral "VIn". The value set modifies the operation of the inverter, during normal operation. The new output value voltage also changes the reference value for the acceptance field of the voltage at the by-pass line input.

1.5.5.5 BATTERY

Press the following sequence of keys to access the menu: 3, 5, 436215, 3

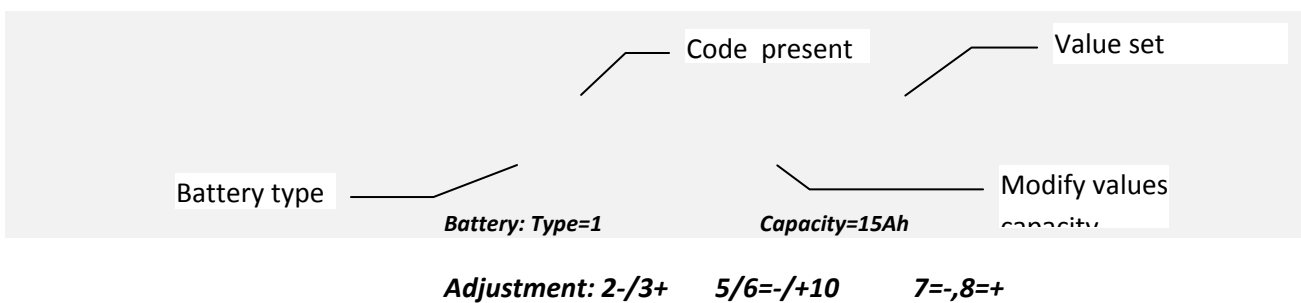

On first installation the rated capacity value of the connected battery must be inserted; this value is usually printed on the battery container.

battery capacity



It is important to insert the correct battery capacity value, since this value is used by the system logic to calculate the backup time.

If not set otherwise, this value is assumed to be equal to the UPS power. e.g. at 100kVA the value set by default is 100Ah .

Battery type = for high intensity discharge batteries, change from value 1 (normally pre-set for normal batteries) to value 2; value 3 is to be used for open vase batteries.

- Display and control panel -

Cyclical battery recharging (factory-set :

Select type 1 or 2 and then press key 4 to display the pre-set voltage values:

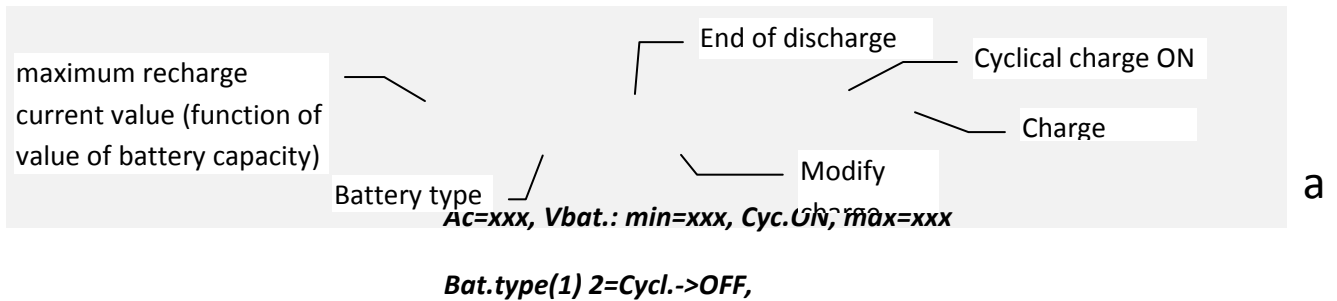

Select type 0 and then press key 4 to modify the voltage values reset by keys 3,4 and 7,8.

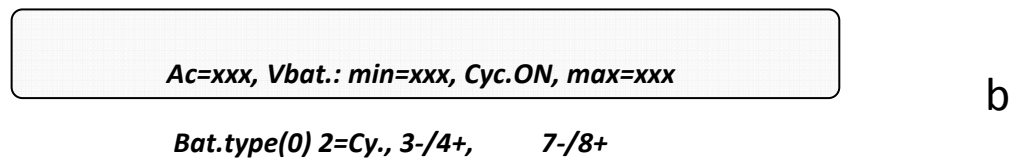

- Display and control panel -

Recharging at two voltage levels (configurable):

This type of recharging is effected with two current levels (EN 50272-2); the first phase comprises rapid charging (U1) with limited current, while in the second phase charging is with float voltage (U2).

N.B.: this type of recharging may be configured on site and is mainly used for special type batteries such as open vase and NiCd.

For batteries of type 1, 2 or 3, press key 2 from menu **a** to change from cyclical charge to charging at two levels

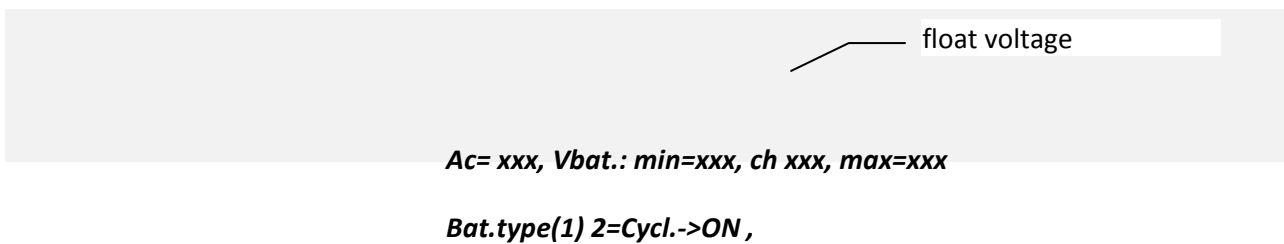

For batteries of type 0, press key 2 from menu **b** to change from **cyclical charge to charging at two levels**

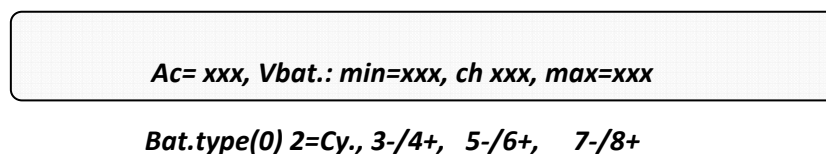

Use keys 3,4; 5,6 and 7,8 to set the values

1.5.5.6 PRE-ALARM

Press the following sequence of keys to access the menu: 3, 5, 436215, 4

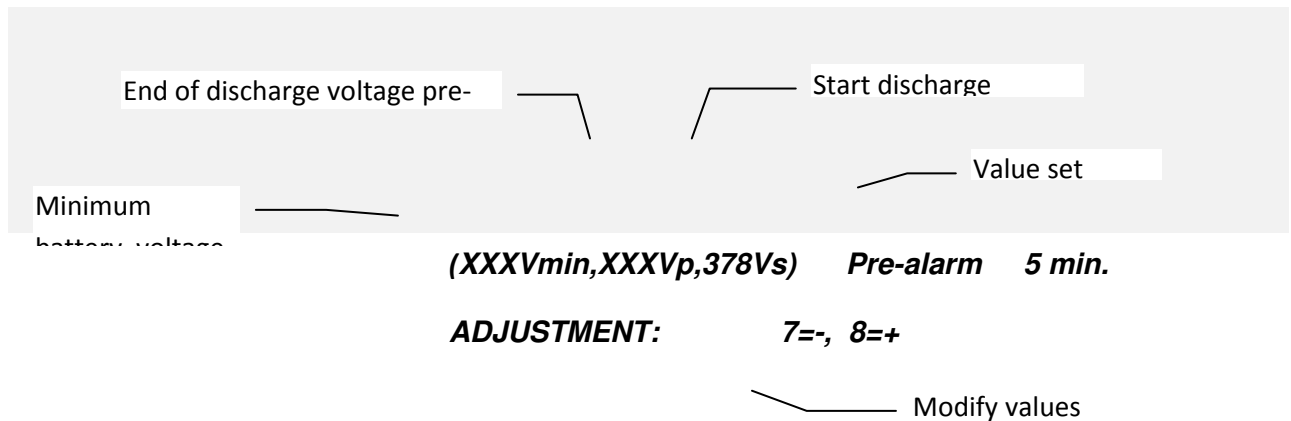

Press key 1 to exit the menu. The menu above will appear with batteries of type 1, 2 or 3.

Voltage values V_{min} , V_p and V_s are not fixed values but are a function of the battery discharge current, [$V_p = V_{min} + 5V + 10 * (\text{battery current [A]} / \text{battery capacity [Ah]})$].

Keys 7 and 8 can be used to decrease or increase the time to activate the pre-alarm before the system blocks due to end of battery discharge. Variations in the field of 1 minute are possible from 2 to 254 minutes.

The pre-alarm signal is activated when the remaining calculated time is lower than the pre-alarm value set or when the battery voltage is lower than the pre-alarm voltage value V_p .

Pre-allarm

 A wide safety margin must be provided for the use of the pre-alarm function, since the expected backup time may not provide for increases of absorption by the output load, and may not make allowance for sudden, unexpected battery defects.

- Display and control panel -

Type "0" Battery

With the battery set to type 0, the following menu is displayed:

(XXXVmin,XXXVp,354Vs) Prealarm : 5min

Adjustment: (4=setV), 7=-,8=+

When key 4 is pressed, the program proposes the setting of the three voltage values.

Vbat.test: Vmin., Vp, Vs: XXX, YYY, ZZZV

Adjustement: 3-4+, 5-6+, 7-8+

Preset value



With the three factory preset voltage values, the display panel may indicate an incorrect backup time during discharge.

Battery type "0" setting

- Display and control panel -

The three values to be set are linked to the **battery discharge regime** (relationship between discharge current / battery capacity in Ah). Example: for a 100Ah battery with a discharge current of 100A,

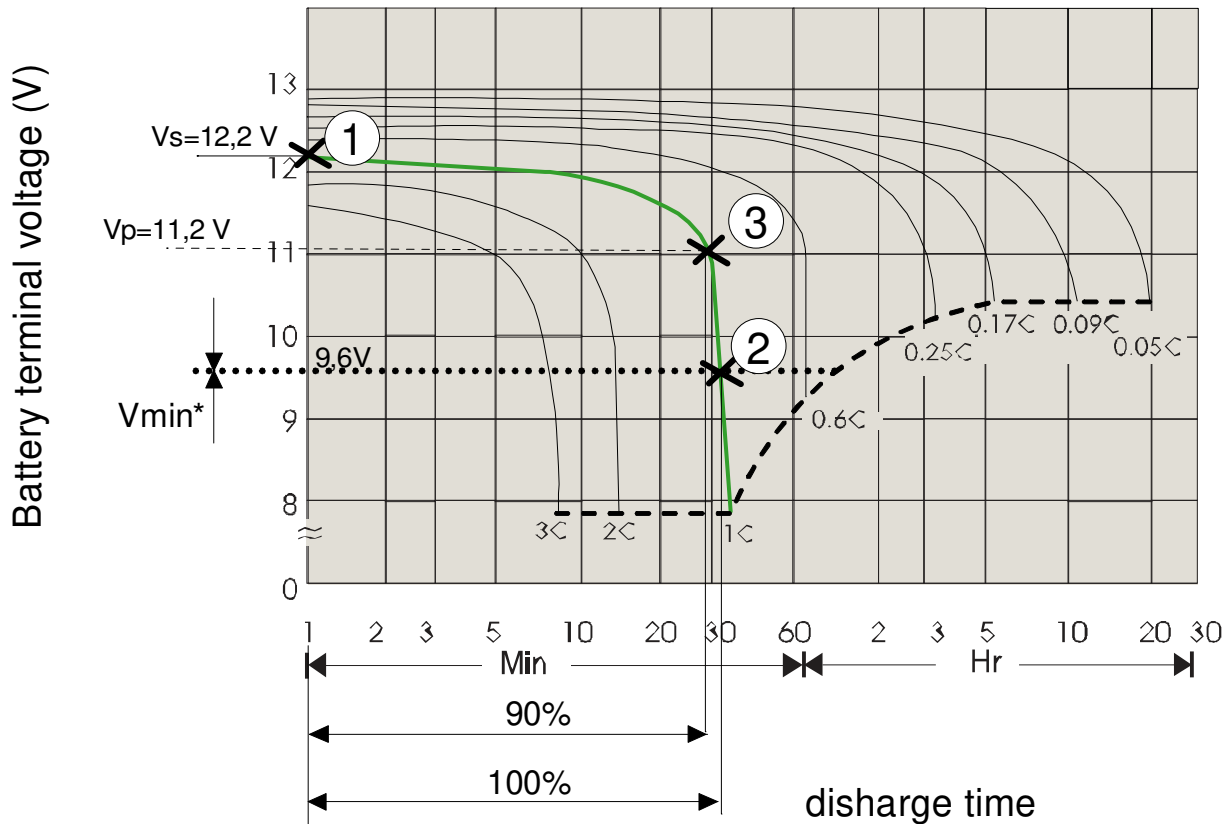

the regime is 1.

The three values, Vs, Vmin and Vp, are obtained from the discharge characteristic curve, supplied from manufacturer, relating to the **battery discharge regime** 1C has been determined:

Vs start of discharge voltage **(1)**, intersection with the x-axis (battery terminal axis),

[the value must be multiply for 40, number of batteries]

Vmin minimum voltage value (end discharge battery), point of intersection with the dashed curve (if this value is lower than Vmin* set up Vmin=Vmin* **(2)**).

[the value must be multiply for 40, number of batteries]

Vp battery voltage with discharge at 90% of the total time **(3)**.

1.5.5.7 AUTO-OFF "VA"

Press the following sequence of keys to access the menu: 3, 5, 436215, 6:

Automatic Switch-OFF when Output < 0%VA

Adjustement: (5=Toff,Ton) 7=-,8=+

Press key 1 to exit the menu.

Keys 7 and 8 can be used to decrease or increase the percentage threshold of the output load for the AUTO-OFF function and the switching of the system on to the by-pass line; variations of 1% are possible in the field from 0 to 99% of the rated output load.

For shutdown with mains present, when the output power reaches < of the value set, the battery charge value must be > 60%.

Once this value is reached the system is deactivated.

For shutdown with power output < value set, it must be verified that the battery capacity value is > 60%.

Shutdown is not immediate, but is delayed by the time set as the end of battery discharge pre-alarm (standard value 5 minutes); in this phase the "end of discharge pre-alarm" contact of the remote alarms card is switched, after this time the output is switched onto the by-pass line if this voltage is present and the voltage also remains present at the output.

The load remains switched onto the by-pass line while the output power remains lower than the "AUTO-OFF" value, then the system waits for an increase in the load before effecting the automatic return to normal operation;

The "AUTO-OFF" function may be used to shut down the system during operation from battery, simply by shutting down the output load. In normal operation, the "AUTO-OFF" function may be used to reset consumption since the power circuits are deactivated, the battery remains isolated and only the control circuits, with consumption equivalent to a light bulb, remain active.

1.5.5.8 AUTO-OFF Timer.

Press the following sequence of keys to access the menu: 3, 5, 436215, 6, 5:

AUTO-OFF Timer: Toff >0: 0', Ton= 0: 0'

ADJUSTMENT: (5=Toff, 6=Ton) 7=-, 8=+

Press key 1 to exit the menu.

The keys have the following functions:

- 6 to modify the value Ton
- 5 to modify the value Toff.

Toff and Ton are time values used by the system to effect an automatic daily shutdown and restart cycle.

The timer cycle is inhibited when Toff = Ton.

When the internal clock reaches the time Toff, if the mains voltage is present and the percentage of recharge is less than 60%, only the following is displayed:

AUTO-OFF Timer: Toff= 20:00', Ton= 7:00'

H100, OUT100% BATT= 50%Ah 5=ON

The system waits until the battery recharge exceeds the value of 60% before deactivating.

When the internal clock reaches the time Toff (20:00'), if the mains voltage is present and the percentage of recharge is greater than 60%, or the mains voltage is not present and operation is from battery, the following is displayed:

AUTO-OFF Timer: Toff= 20:00', Ton= 7:00'

H100, OUT100% OFF:4 min 5=ON

- Display and control panel -

The "end of discharge pre-alarm" contact for remote alarms is also switched.

In this case the system remains active for the next 4 minutes, after which the system switches onto the by-pass line and then deactivates.

There is no output voltage after deactivation.

The interval between the start of the alarm and deactivation is equal to the interval selected as PRE-ALARM.

When the internal clock reaches the time T_{on} (7:00'), if the mains voltage is present, the system automatically reactivates and returns to normal operation.

1.5.5.9 BY-PASS VOLTAGE FIELD

Press the following sequence of keys to access the menu: 3,5,436215, 7, 2:

Press key 1 to exit the menu. Keys 7 and 8 can be used to decrease or increase the value percentage of the field for the acceptance of the voltage at the by-pass line input, with respect to the rated output value.

With the UPS in standby-ON mode, the menu is as follows:

(StbyON=15%) BY. VOLTAGE RANGE = +/- 15%

ADJUSTMENT: (5-, 6+)

7=-, 8=+

Keys 5 and 6 can be used to reduce or increase the percentage of the acceptance field of the bypass voltage in STBY ON mode.

1.5.5.10 BY-PASS FREQUENCY FIELD.

Press the following sequence of keys to access the menu: 3,5,436215,7, 3:

Press any key other than 7 or 8 to exit the menu. Keys 7 and 8 can be used to decrease or increase the value percentage of the field for the acceptance of the frequency at the by-pass line input. The choice is between the values +/- 1%, and +/- 5% relating to the rated system value of 50 or 60 Hz .

1.5.5.11 MODEM

Press the following sequence of keys to access the menu: 3, 5, 436215,7, 4:

MODEM enable = 0,

ADJUSTMENT: (5=dial, 6=send) 7=-, 8=+

Press key 1 to exit the menu.

Keys 7 and 8 can be used to decrease or increase the control value for management of the modem. The choice is between values 0 to 5 and the initial value is 0.

0 = the modem connected to the RS232 port is deactivated, since terminal 20 of the RS232 connector assumes a low level (-12V) (DTR signal deactivated).

N.B. the configuration MODEM=0 is essential when the modem is not used and the RS232 connector is used for connection to the remote panel.

1= signal DTR is activated (terminal 20 at +12V), the modem is enabled to reply (it should be remembered that a remote panel connected to the RS232 connector in place of the modem remains off).

2= signal DTR is activated, the modem is ready to reply and for automatic calls.

- Display and control panel -

After an "internal fault" alarm has been on for 30 seconds, the system automatically dials the stored "DIAL" number. When it receives the modem's receiving reply it sends a message made up of the UPS acronym, the stored "SEND" number, the copy of the text shown on the display, the alarm code and the date and time of transmission.

N.B.: for correct operation, use a modem that has already been configured to recognize "HAYES" type commands and that is able to dial the telephone number using pulses or tones as required by the telephone line that is to be used.

Example of messages sent to the modem in the event of an "INTERNAL FAULT 5" alarm.

Supposing that the settings are as follows: Modem =2, Dial=23456, Send=123456.

30 seconds after the start of the persistent alarm, the system sends the modem the command:

```
ATD 23456
```

On receiving the message "CONNECT" from the modem, the system sends: *UPS 123456*

```
INTERNAL FAULT: 5
```

```
100, OUT=100%VA, BATT= 78%Ah, 5=ON a=00200300 1999-12-21, 13:12:28
```

The system then sends the sequence to close the communication:

```
+++ ATH
```

Lastly, signal DTR is also lowered for 0.5 sec.

If the telephone line is engaged or the remote modem does not reply, the system tries to call again every 5 minutes until it manages to connect, provided that the alarm condition is still present.

3= like 2 with automatic call when any alarm is verified.

4= like 2 with automatic call only for alarms 10, and with sending of message only after the reply from the remote modem has been acknowledged by the reception of the character "}".

This mode ensures that the receiving computer does not lose any messages.

5= like 4 with automatic call when any alarm is verified.

1.5.5.12 "DIAL /SEND" MODEM

Press the following sequence of keys to access the menu: 3, 5, 436215, 7, 4, 5 (6):

MODEM dial n.=6543210///////// <=2..3=>

ADJUSTMENT: (5=dial, 6=send) 7=-, 8=+

Press key 1 to exit the menu.

Keys 7 and 8 can be used to decrease or increase the figure on which the cursor is positioned.

The cursor is moved by means of keys 2 and 3, and is indicated initially by the character '_ '.

Each number may assume values from 0 to 9, the symbol / indicates that the corresponding figure is disabled.

A correct "dial" number must start with a figure from 0 to 9, the setting /6543210 is ignored.

Select menu 35746 or press key 6 when menu 35745 is active to set the "send" number.

1.5.5.13 RS232

Press the following sequence of keys to access the menu: 3, 5, 436215, 7, 5:

Press key 1 to exit the menu. Keys 7 and 8 for RS232-1 (3 and 4 for RS232-2) can be used to decrease or increase the baud value for the transmission speed. The choice is between the values 1200, 2400, 4800, 9600.

1.5.5.14 ECHO.

Press the following sequence of keys to access the menu: 3, 5, 436215, 7, 6:

Press key 1 to exit the menu. Keys 7 and 8 can be used to decrease or increase the number used to enable the "ECHO" function. The number may vary from 0 to 1 to disable or enable the function. When the function is enabled the system automatically sends a copy message of the display with the addition of the code "a=....." and the current date and time to the RS232 output.

The message is sent for each variation in the state of the alarms (that is, any change in code a=.....).

1.5.5.15 IDENT.

Press the following sequence of keys to access the menu: 3, 5, 436215, 7, 7:

Press key 1 to exit the menu. Keys 7 and 8 can be used to decrease or increase the number used for the identification of a single unit in systems with several UPS connected to a single RS232 serial line. The basic number is 0 and may be changed between values from 0 to 7.

1.5.5.16 OPERATION IN STANDBY-ON

Press the following sequence of keys to access the menu: 3,5,436215,8:

Stby= 2sec. Stby_ON= 0

Adjustment: 4=Sma.ON, 5-,6+ 7=-,8=+

Press key 1 to exit the menu. Press key 8 Stby=1 to change the UPS from ON-LINE mode to STANDBY-ON mode, press 7 for the other way round. The switch onto the by-pass line may be immediate when "Stby = 0 min." or delayed by means of keys 5 and 6. The backup line must be available for the time set within the acceptance field before the switchover can take place (see "PERSONALIZ. BYPASS VOLTAGE

FIELD” menu). The setting remains stored even during a shutdown due to a power failure. For the description of the operation see the section “SETTING MODES” on the UPS User manual.

1.5.5.17 SMART ACTIVE OPERATION

Press the following sequence of keys to access the menu: 3,5,436215,8,4:

SMART ACTIVE S. Stby = 5 min. Stby_ON = 1

Adjustment: 4=Sma.OFF, 5-,6+ 7= -, 8 = +

Press key 1 to exit the menu. When the Smart Active function is activated via key 4, Stby_ON goes to 1. The setting remains stored even during a shutdown due to a power failure. There is a delay of 5 minutes before transfer to SMART ACTIVE mode. For the description of the operation see the section “SETTING MODE”.

When the code is inserted the basic menu becomes:

NORMAL OPERATION SMART A.

P200, M OUT= 99%VA, BATT= 100%Ah, 5=ON

1.5.5.18 INVERTER-OFF/BY-PASS

Press the following sequence of keys to access the menu: 3, 6 :

Exit the menu by pressing key 8 or any other key with a sequence other than the one described here. Pressing keys 4, 7, 2, 6, 3 in succession as shown on the display activates the command for by-pass with shutdown of the inverter. The command is executed after a few seconds' delay to allow for any cancellations. When this command is active, the following alarm is shown on the display:

"BY-PASS COMMAND ACTIVE; 8=DEACTIV. "

To return to normal operation, including after system shutdown, the command has to be cancelled by pressing key 8, or by sending the key code through the RS232.

N.B. To mask the command code 47263, insert code 436213 on the panel from the PERSONALIZATIONS menu (keys 3,5). Repeat the operation to display the code again.

1.5.5.19 TOTAL BLOCK

Press the following sequence of keys to access the menu: 3, 7 :

Total System Shut-OFF Command = 47263

WARNING, the Output Voltage will be OFF

Exit the menu by pressing key 8 or any other key with a sequence other than the one described here. Pressing keys 4, 7, 2, 6, 3 in succession as shown on the display activates the command for the TOTAL BLOCK of the system. When this command is active, the display shows the alarm

BLOCK COMMAND ACTIVE; 8=DEACTIV.

The command is executed after a few seconds' delay to allow for any cancellations. This command is useful to achieve full deactivation in an emergency, operating remotely via the RS232 line. To reactivate the UPS close disconnecter SWBY or, if applicable, press button 8.

N.B. To mask the command code 47263, insert code 436213 on the panel from the PERSONALIZATIONS menu (keys 3,5). Repeat the operation to display the code.

1.5.6 "RECORDER": RECORDED EVENTS

Press the following sequence of keys to access the menu: 4

if there are alarms, the active ALARM messages are displayed

The "RECORDED VOLTAGES MEASUREMENTS" menu is accessed via key **STOP**

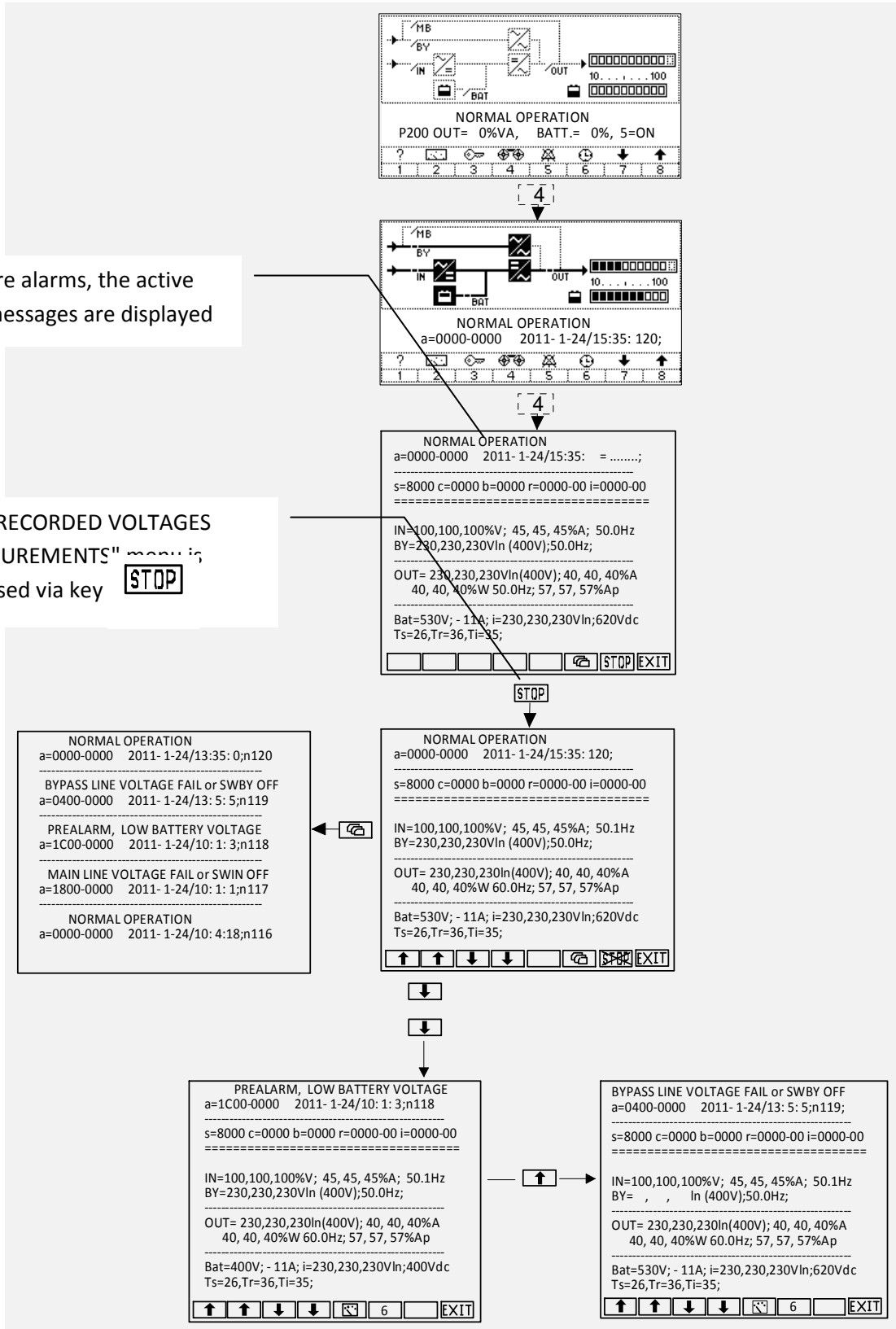

1.5.7 EXCLUDING THE ACOUSTIC ALARM

Press the following sequence of keys to access the menu: 5

During operation from the basic menu, the operator can permanently exclude or re-enable the acoustic alarm by pressing key 5. "5=ON" is shown in the basic menu when the acoustic alarm is enabled and "5=OFF" when the acoustic alarm is excluded. Key 5 in other menus may only be used to exclude the sound, when no other functions are envisaged for this key. The command is stored even during a shutdown due to a power failure.

1.5.8 "CLOCK": DATE/TIME

Press the following sequence of keys to access the menu: 6

The "DATE/TIME" menu is accessed via key 6 from the basic menu.

The display shows the current contents of the internal calendar and clock with the following format:

DATE/TIME = ymd/h = years, months, days / hours, minutes, seconds.

The contents can be modified via the menu by inserting the personalization code 436215.

The code is no longer required for 2 minutes after it has previously been inserted.

The next menu can only be accessed by inserting the correct code, otherwise the system returns to the basic menu.

Press keys 2, 3, 4, 5 or 6 to select which value to change.

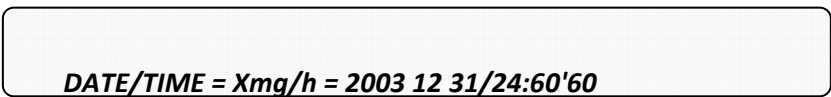

DATE/TIME = Xmg/h = 2003 12 31/24:60'60

ADJUSTMENT: 7=-, 8=+

In this case the years value is to be changed; the flashing symbol X superimposed over the letter shows which field has been selected. Press keys 7 or 8 to increase or decrease the selected value by one unit; press any one of the other keys to exit the menu.

1.5.9 "ARROW DOWN": INTERNAL CODES

Press the following sequence of keys to access the menu: 7

s=FFFF c=FFFF b=FFFF r=FFFF-FF i=FFFF-FF

a=FFFF-FFFF; INTERNAL CODES; ver.10.....

The "INTERNAL CODES" menu is accessed from the basic menu via key 7. The codes represented provide information on the operating status of the UPS. This information is used by the service personnel .

AGKK10450 12/2012