



MTR SERIES

Rack Modular UPS

10-15-20-30-40-45- 60-90 kVA

3 Ph Input - 3 Ph Output

Safety Precautions

This manual contains information concerning the installation and operation of Modular UPS. Please carefully read this manual prior to installation.

The Modular UPS cannot be put into operation until it is commissioned by engineers approved by the manufacturer (or its agent). Not doing so could result in personnel safety risk, equipment malfunction and invalidation of warranty.

The UPS has been designed for commercial or industrial use only, and is not intended for use in any life support application. This is a CLASS C Uninterruptible Power Supply (UPS) product. In a domestic environment, this product may cause radio interference, in which case, the user may be required to take additional measures.



Conformity and standards

This product complies with CE73/23 & 93/68 (low voltage safety) and 89/336 (EMC), and the following UPS product standards:

*IEC62040-1-1-General and safety requirements for use in operator access area

*IEC/EN62040-2 EMC requirements CLASS C

*IEC62040-3 Performance requirements and test methods

For more details, refer to Chapter 9 . Continued compliance requires installation in accordance with these instructions and the use of manufacturer approved accessories only.



WARNING: high earth leakage current

Earth connection is critical before connecting the input supply (include both utility supply and battery).

"Earth leakage current introduced by the UPS, in any configuration from 10kW to 150kW, exceeds 3.5 mA and is less than 1000 mA and complies with the requirements of IEC/EN 62040-1 / IEC/EN 60950-1" Transient and steady-state earth leakage currents, which may occur when starting the equipment, should be taken into account when selecting instantaneous RCCB or RCD devices. Residual Current Circuit Breakers (RCCBs) must be selected sensitive to DC unidirectional pulses (class A) and insensitive to transient current pulses.

Note also that the earth leakage currents of the load will be carried by this RCCB or RCD.

This equipment must be earthed in accordance with local electrical authority codes of practice.



WARNING: backfeeding protection

This system has a control signal available for use with an automatic device, externally located, to protect against backfeeding voltage through the mains Static Bypass circuit. If this protection is not used with the switchgear that is used to isolate the bypass circuit, a label must be added to the switchgear to advise service personnel that the circuit is connected to a UPS system.

The text has the following meaning or is equivalent to: Isolate the UPS before working on the circuit of this UPS.



Components that can be maintained by user

All the equipment maintenance and servicing procedures involving internal access need special tools and should be carried out only by trained personnel. The components that can only be accessed by opening the protective cover with tools cannot be maintained by user.

This UPS full complies with "IEC62040-1-1-General and safety requirements for use in operator access area UPS". Dangerous voltages are present within the battery box. However, the risk of contactor with these high voltages is minimized for non-service personnel. Since the component with dangerous voltage can only be touched by opening the protective cover with a tool, the possibility of touching high voltage component is minimized. No risk exists to any personnel when operating the equipment in the normal manner, following the recommended operating procedures in this manual.



Battery voltage higher than 400Vdc

All the battery maintenance and servicing procedures involving internal access need special tools or keys and should be carried out only by trained personnel.

SPECIAL CARE SHOULD BE TAKEN WHEN WORKING WITH THE BATTERIES ASSOCIATED WITH THIS EQUIPMENT.

WHEN CONNECTED TOGETHER, THE BATTERY TERMINAL VOLTAGE WILL EXCEED 400Vdc AND IS POTENTIALLY LEATHAL.

Battery manufacturers supply details of the necessary precautions to be observed when working on, or in the vicinity of, a large bank of battery cells. These precautions should be followed implicitly at all times. Particular attention should be paid to the recommendations concerning local environmental conditions and the provision of protective clothing, first aid and fire-fighting facilities.

Contents

Safety Precautions	III
Chapter 1 Installation	1
1.1 Introduction	1
1.2 Initial Checking	1
1.3 Location	1
1.3.1 UPS Location	1
1.3.2 External Battery Room	2
1.3.3 Storing	2
1.4 Positioning	2
1.4.1 System Cabinet	2
1.4.2 Moving the Cabinets	2
1.4.3 Clearances Required for Operating	3
1.4.4 Front Access	3
1.4.5 Final Positioning	3
1.4.6 Installation of Adjustable Feet	3
1.4.7 UPS Composition	3
1.4.8 Installing Power Modules	4
1.4.9 Cable Entry	6
1.5 External Protective Devices	8
1.5.1 Rectifier and Bypass Input Supply of the UPS	8
1.5.2 External Battery	8
1.5.3 UPS Output	8
1.6 Power Cables	8
1.6.1 Cable Connections	9
1.7 Control Cabling and Communication	10
1.7.1 UPS Dry Contactor and Monitoring Board Features	10
1.7.2 Dry Contactor Interface of Battery and Environmental Temperature Detection	11
1.7.3 Remote EPO Input Port	12
1.7.4 Generator Input Dry Contactor	12
1.7.5 BCB Input Port	13
1.7.6 Battery Warning Output Dry Contactor Interface	13
1.7.7 Integrated Warning Output Dry Contactor Interface	14
1.7.8 Mains Failure Warning Output Dry Contactor Interface	15
Chapter 2 Battery Installation and Maintenance	16
2.1 General Recommendations	16
2.2 Battery Typologies	17
2.2.1 Traditional Battery Installation	17
2.3 Battery Maintenance	18
Chapter 3 Installation of UPS Rack System	19
3.1 Overview	19
3.2 UPS Rack Modules in Parallel System	20
3.2.1 Installation of Cabinet	20
3.2.2 External Protective Devices	20
3.2.3 Power Cables	20
3.2.4 Parallel Signal Board	20
3.2.5 Control Cables	20
Chapter 4 Installation Drawing	22

Chapter 5 Operations	29
5.1 Introduction.....	29
5.1.1 Split-Bypass Input.....	29
5.1.2 Static Transfer Switch	30
5.2 1+1 Parallel System.....	30
5.2.1 Features of Parallel System.....	30
5.2.2 Parallel Requirements of UPS Modules	30
5.3 Operating Mode.....	31
5.3.1 Normal Mode.....	31
5.3.2 Battery Mode.....	31
5.3.3 Auto-Restart Mode.....	31
5.3.4 Bypass Mode.....	31
5.3.5 Maintenance Mode (Manual Bypass)	31
5.3.6 Parallel Redundancy Mode (System Expansion)	31
5.3.7 Eco Mode.....	31
5.4 Battery Management—Set During Commissioning	32
5.4.1 Normal Function	32
5.4.2 Advanced Functions (Software Settings Performed by the Commissioning Engineer) 32	
5.5 Battery Protection (Settings by Commissioning Engineer).....	32
Chapter 6 Operating Instructions	33
6.1 Introduction.....	33
6.1.1 Power Switches.....	33
6.2 UPS Startup.....	33
6.2.1 Start-Up Procedure	33
6.2.2 Procedures for Switching Between Operation Modes	34
6.3 Procedure for Switching the UPS between Maintenance Bypass and Normal Mode.....	35
6.3.1 Procedure for Switching from Normal Mode to Maintenance Bypass Mode.....	35
6.3.2 Procedure for Switching from Maintenance Mode to Normal Mode	35
6.4 Procedure for Completely Powering Down a UPS.....	36
6.5 EPO Procedure	36
6.6 Auto Start	36
6.7 UPS Reset Procedure.....	37
6.8 Operation Instruction for Power Module Maintenance.....	37
6.9 Language Selection	38
6.10 Changing the Current Date and Time	38
6.11 Control Password 1.....	38
Chapter 7 Operator Control and Display Panel	39
7.1 Introduction.....	39
7.1.1 Mimic Current Path	40
7.1.2 Audible Alarm (buzzer).....	40
7.1.3 Functional Keys	40
7.1.4 Battery Pack Indicator	41
7.2 LCD Display Type.....	41
7.3 Detailed Description of Menu Items.....	42
7.4 UPS Event Log.....	48
Chapter 8 Optional Parts	53
8.1 Install SNMP card	53
Chapter 9 Product Specification	54
9.1 Applicable Standards	54
9.2 Environmental Characteristics	54

9.3 Mechanical Characteristics	54
9.4 Electrical Characteristics (Input Rectifier).....	54
9.5 Electrical Characteristics (Intermediate DC Link)	55
9.6 Electrical Characteristics (Inverter Output)	55
9.7 Electrical Characteristics (Bypass Input).....	56
9.8 Efficiency	56
Appendix A Guide for Ordering and Selection of UPS Rack System.....	57
Appendix B. Power Connection of Modular System	58
Appendix C. Cold Start (Professional Version)	60

Table of Figures

Fig.1- 1: UPS Structure	4
Fig.1- 2: Power Module Installation.....	5
Fig.1- 3: rack mounted installation.....	6
Fig.1- 4: cable entry	7
Fig.1- 5: The Symbols of RCCB	8
Fig.1- 6: Bypass Module (include bypass and monitoring)	11
Fig.1- 7: Diagram of J2 and J3 Dry Contactor of Temperature Detection.....	11
Fig.1- 8: Diagram of Input Dry Contactor for Remote EPO.....	12
Fig.1- 9: Connection of Generator	13
Fig.1- 10: BCB Interface	13
Fig.1- 11: Battery Low Warning Dry Contactor.....	14
Fig.1- 12: Integrated warning dry contactor	14
Fig.1- 13: Utility Failure Warning Dry Contactor	15
Fig.2- 1: Diagram of Batteries Connection	17
Fig.3- 1: Circuit diagram of EPO	19
Fig.3- 2: Parallel Board	20
Fig.3- 3: Connection of Parallel Cables of "1+N" System.....	21
Fig.4- 1: Wiring Diagram	22
Fig.4- 2: External Battery Connection.....	23
Fig.4- 3: 90kVA UPS module System, Front View and Rear View without Door	23
Fig.4- 4: 40KVA UPS Module System, Front View and Rear View without Door	23
Fig.4- 5: 20KVA UPS Module System, Front View and Rear View without Door	24
Fig.4- 6: 90KVA UPS External Dimensions	24
Fig.4- 7: 40KVA UPS External Dimensions	24
Fig.4- 8: 20KVA UPS External Dimensions	25
Fig.4- 9: Power Connection of Module System UPS	26
Fig.4- 10: Power Module.....	26
Fig.4- 11: Monitoring and Bypass Module	27
Fig.4- 12: cables routing (dry contactor, RS485, SNMP).....	28
Fig.5- 1: Single Unit Block Diagram.....	29
Fig.6- 1: External Maintenance Bypass.....	35
Fig.7- 1: UPS operator control and display panel	39
Fig.7- 2: Main LCD Display	41
Fig.7- 3: Menu Structure	42
Fig.7- 4: cabinet menu	43
Fig.7- 5: main input and output information.....	43
Fig.7- 6: load and battery information.....	44
Fig.7- 7: power module information	44
Fig.7- 8: module output and load information	45
Fig.7- 9: module information and S-code.....	45
Fig.7- 10: Setting Menu.....	45
Fig.7- 11: System Operate	47
Fig.7- 12: output and bypass waveform	48
Fig.8- 1: SNMP card.....	53
Fig.B- 1: Power Connection of 2 slots and 4 slots	58
Fig.B- 2: Power Cables Connection of 6 slots cabinet	58

Table of Tables

Table.1- 1: UPS Configuration List.....	4
Table.1- 2: Maximum Steady State AC and DC Current.....	8
Table.1- 3: Description of Input Dry Contactor	11
Table.1- 4: Description of Input Dry Contactor for Remote EPO	12
Table.1- 5: Description of Status Interface and Connection of Generator	13
Table.1- 6: Description of BCB Interface	13
Table.1- 7: Battery warning dry contactor interface description	14
Table.1- 8: Integrated warning dry contactor interface description.....	14
Table.1- 9: Description of Mains failure warning dry contactor	15
Table.7- 1: Description of UPS Operator Control and Display Panel	39
Table.7- 2: Status Description of Indicator	40
Table.7- 3: Description of Audible Alarm.....	40
Table.7- 4: Functions of Functional Keys.....	40
Table.7- 5: Description of LCD Icons	41
Table.7- 6: Description of Items in UPS System Information Window.....	42
Table.7- 7: description of details of submenu in setting	45
Table.7- 8: UPS Event List	48
Table.9- 1: Compliance with European and International Standards.....	54
Table.9- 2: Environmental Properties	54
Table.9- 3: Mechanical Properties.....	54
Table.9- 4: Rectifier AC Input (mains).....	54
Table.9- 5: Battery Information.....	55
Table.9- 6: Inverter Output (to Critical Load).....	55
Table.9- 7: Bypass Input	56
Table.9- 8: Efficiency, Air Exchange.....	56

Chapter 1 Installation

1.1 Introduction

This chapter introduces the relevant requirements for positioning and cabling of the Modular UPS and related equipment. Because each site has its requirements, it is not the aim of this chapter to provide step-by-step installation instructions, but to act as a guide for the general procedures and practices that should be observed by the installing engineer.



Warning: installation can only be done by authorized engineers

Do not apply electrical power to the UPS equipment before the commissioning engineer arrives at installation site. The UPS should be installed by a qualified engineer in accordance with the information contained in this chapter. All the equipment not referred to in this manual is shipped with details of its own mechanical and electrical installation information.



Note: 3-Phase 4-Wire Input Power is required

The standard UPS system can be connected to TN, TT AC distribution system (IEC60364-3) of 3-phase 4-wire, and a 3-wire to 4-wire conversion transformer is provided as an optional part. 1-phase 3-wires is also provided as an optional part.



WARNING: battery hazards

SPECIAL CARE SHOULD BE TAKEN WHEN WORKING WITH THE BATTERIES ASSOCIATED WITH THIS EQUIPMENT.

When connecting the battery, the battery terminal voltage will exceed 400Vdc and is potentially lethal.

- Eye protection should be worn to prevent injury from accidental electrical arcs.
- Remove rings, watches and all metal objects.
- Only use tools with insulated handles.
- Wear rubber gloves.
- If a battery leaks electrolyte, or is otherwise physically damaged, it must be replaced, stored in a container resistant to sulfuric acid and disposed of in accordance with local regulations.
- If electrolyte comes into contact with the skin, the affected area should be washed immediately with water.

1.2 Initial Checking

Perform the following checking operations prior to the UPS installation.

1. Visually examine if there is any damage inside and outside the UPS rack and battery equipment due to the transportation. Report any such damage to the shipper immediately.
2. Verify the product label and confirm the correctness of the equipment. The equipment label is attached on the back of front door. The UPS model, capacity and main parameters are marked on the label.

1.3 Location

1.3.1 UPS Location

The UPS is intended for indoor installation and should be located in a cool, dry and clean environment with adequate ventilation to keep the environmental parameters within the specified operating range (see *Table.9-2*). The Modular series UPS uses forced convection cooling by internal fans. Cooling air enters the module through ventilation grills located at the front part of the cabinet and exhausted through grills located in the rear part of the cabinet. Please do not block the ventilation holes.

If necessary, a system of extractor fans should be installed to aid cooling-air flow. An air filter should be used when the UPS is to operate in a dirty environment and should be regularly cleaned to maintain airflow. The cooling capacity of air conditioner should be selected according to the power loss data of UPS specified in *Table.9-8*: Normal mode (VFI SS 111 double-conversion UPS)

Note: The UPS should be installed on a cement surface or other surface that is not combustible.

1.3.2 External Battery Room

The battery will generate some amount of hydrogen and oxygen at the end of charging, so the fresh air volume of the battery installation environment must meet EN50272-2001 requirements.

The ambient temperature of the battery must be stable. Ambient temperature is a major factor in determining the battery capacity and life. The nominal operating temperature of battery is 20°C. Operating above this temperature will reduce the battery life, and operation below this temperature will reduce the battery capacity. If the average operating temperature of battery is increased from 20°C to 30°C, then the service life of the battery will be reduced by 50%. If the operating temperature of the battery is above 40°C, then the battery service life will be decreased in exponent rate. In a normal installation, the battery temperature is maintained between 15°C and 25°C. Keep batteries away from heat sources or air outlets.

If external batteries are to be used, the battery circuit breakers (or fuses) must be mounted as close as possible to the batteries, and the connecting cables should be as short as possible.

1.3.3 Storing

Should the equipment not be installed immediately, it must be stored in a room so as to protect it against excessive humidity and heat sources (see *Table.9-2*).The battery needs to be stored in dry and cool place with good ventilation. The most suitable storage temperature is 20 °C to 25°C.



Preventing battery deep discharge

Should the UPS remains unpowered for a prolonged period of time while the battery are connected, the batteries may deeply discharge and being so permanently damaged .In such cases it is therefore recommended to leave the battery circuit breaker(s) open. During storage in any case, periodically charge the battery according to the battery user manuals.

1.4 Positioning

When the equipment has been finally positioned, ensure the UPS will remain stationary and stable. To prolong the service life, the place chosen must guarantee:

- Space for easy operation on the UPS
- Air sufficient enough to dispel heat produced by UPS
- Against atmospheric agents
- Against excessive humidity and heat sources
- Against dust
- With the current fire prevention requirements
- The operating environment temperature is within +20°C to +25°C. The batteries are at maximum efficiency in this temperature range (for information about the battery storage and transportation as well as the environment, refer to *Table.9-2*)
- This equipment is of steel frame structure wrapped by removable panels. The top and side panels are fixed by screws.
- After opening the UPS rack door, the auxiliary connections for external low voltage interface and the maintenance bypass can be accessed. The UPS rack has an operator and control panel located on its front door, which provides the basic operating status and alarm information. Batteries are external. The UPS provides air inlet port in the front and the air exhaust port in the rear part.

1.4.1 System Cabinet

A UPS system can comprise an UPS rack system, external battery cabinet, depending on the specific system requirement.

All the UPS system cabinets used in the same installation site are of the same height and should be positioned side-by-side to achieve an aesthetically appealing effect. Refer to Chapter 7 Installation Drawing for the positioning of UPS cabinet.

1.4.2 Moving the Cabinets



Warning

Ensure that any lifting equipment used in moving the UPS cabinet has sufficient lifting capacity. The UPS is fitted with castors – take

care to prevent movement when unbolting the equipment from its shipping pallet. Ensure adequate personnel and lifting aids are available when removing the shipping pallet.

Ensure that the UPS weight is within the weight loading capacity range of any hoisting equipment. See *Table.9-3* for UPS weight.

UPS and optional cabinets can be handled by means of a fork lift or similar equipment. The UPS cabinet can also be moved by its castors when moving in a short distance.

Note: Care must be taken when handling units fitted with batteries. Keep such moves to a minimum.

1.4.3 Clearances Required for Operating

As rack module UPS has no ventilation grills at either sides, no clearances are required for the sides.

To enable routine tightening of power terminations within the UPS, it is recommended that clearance around the front of the equipment should be sufficient to enable free passage of personnel with the doors fully opened. It is important to leave a distance of 500mm in the rear side of the rack to permit adequate circulation of air coming out of the unit.

If the UPS make use of internal modular battery sufficient clearing shall be given at the back site to allow personnel to operate the battery circuit breakers

1.4.4 Front Access

The component layout of the UPS rack system supports front access and repairing the UPS, thus reducing the space requirement for side access.

1.4.5 Final Positioning

When the equipment has been finally positioned, ensure the adjustable feet are set so that the UPS will remain stationary and stable.

1.4.6 Installation of Adjustable Feet

Installation diagrams in Chapter 4 of this manual identify the location of the holes in the base plate through which the equipment can be bolted to the floor. If the UPS is to be located on a raised floor, it should be mounted on a pedestal suitably designed to accept the UPS point loading (more than 150 kg).

1.4.7 UPS Composition

The UPS structure is shown in *Fig. 1-1*. The UPS configuration is provided in *Table. 1-1*

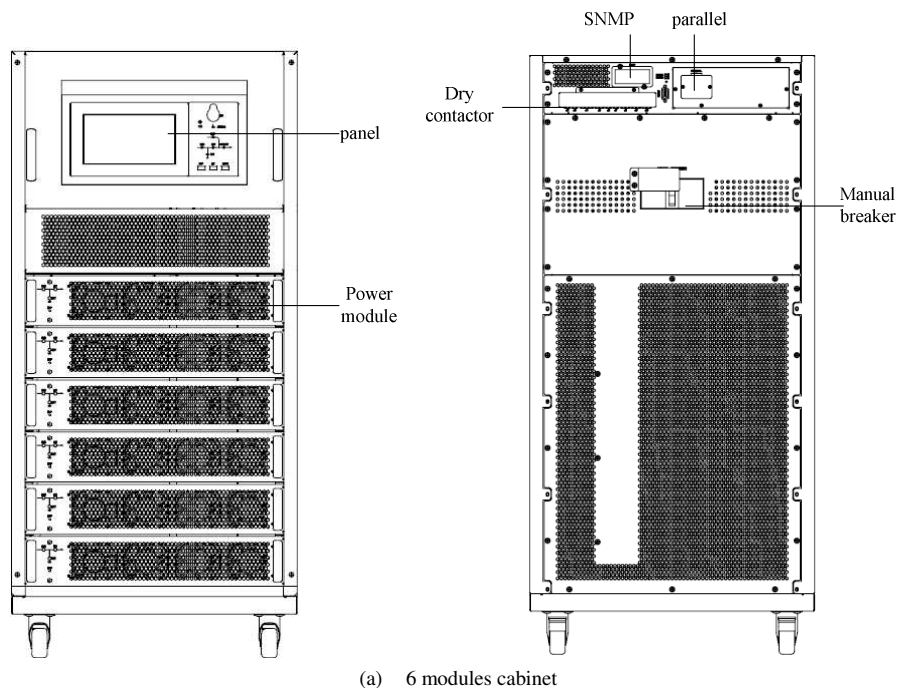

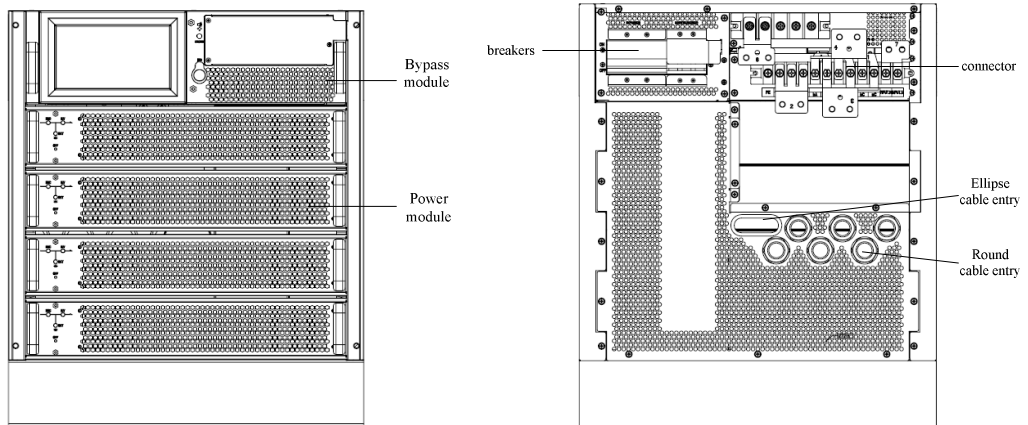

(b) 4 modules cabinet

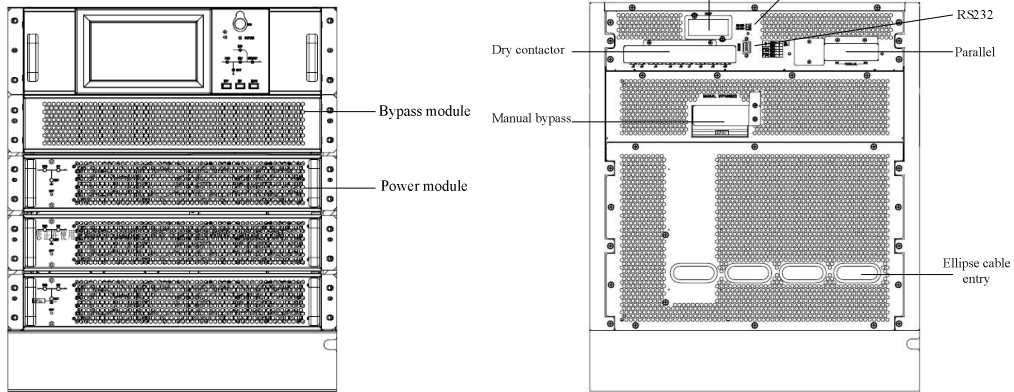

(c) 3 modules cabinet

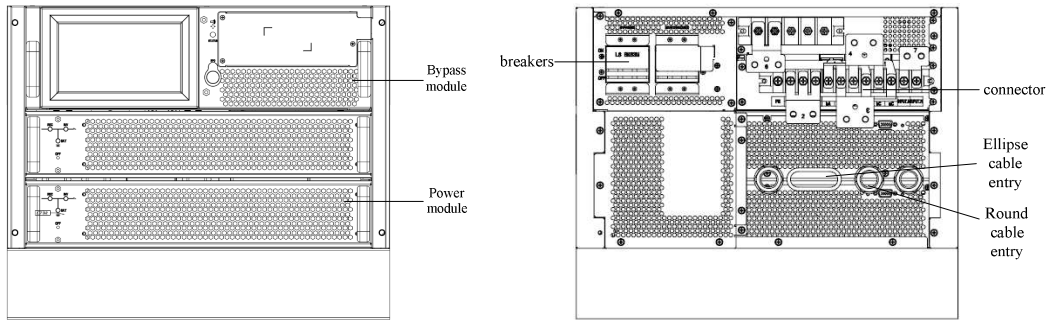

(d) 2 modules cabinet

Fig.1- 1: UPS Structure

Table.1- 1: UPS Configuration List

Item	Component	Quantity	Remarks
1	System Display	1	Requisite, factory installed
2	Bypass module	1	Requisite, factory installed
3	Bypass/maintenance bypass breakers	1	Requisite, factory installed
4	Power module	$1 \leq n \leq 6$	Requisite
5	Decorative metal strip	2	Factory installed

1.4.8 Installing Power Modules

The number and possible installation positions of the Power Modules may vary according to the chosen factory configuration. Please

install the power modules from bottom to top, so as to avoid cabinet toppling due to high gravity center.

Installation procedures of power modules

When installing power modules always work from the lower available space upwards to prevent from raising the center of gravity. The default setting from the bottom space upwards is NO.1 to NO.2 (2 modules cabinet), NO.1 to NO.3 (3 modules cabinet), NO.1 to NO.4 (4 modules cabinet), NO.1 to NO.6 (6 modules cabinet).



Notes

If installed as standalone unit, it's recommended that install power modules from upper available space downwards to prevent from corrosion of the bottom module.

- Recover decorative metal strips on the two side of front panel. Loose screws through holes on metal strips, **pull metal strips upwards** then take away the strips as *Fig.1-2(a)*.
- Insert the module in the installation position, and push it into the cabinet.
- Secure the module to the cabinet through the fixing holes on both sides of the front panel of the module.
- Loose the upper and bottom 4 screws and fix two side decorative metal strips (as *Fig.1-2*) to cover the screws on front side following *Fig.1-2(c)(d)*.

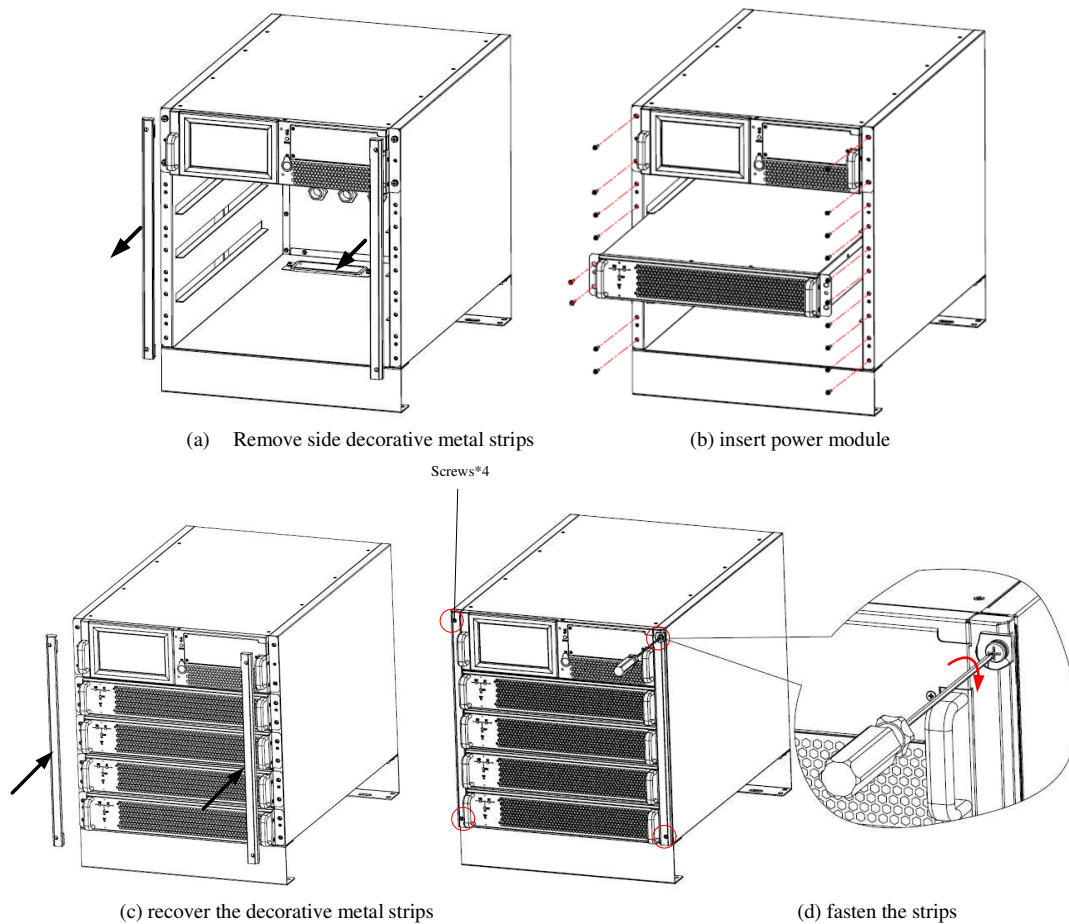
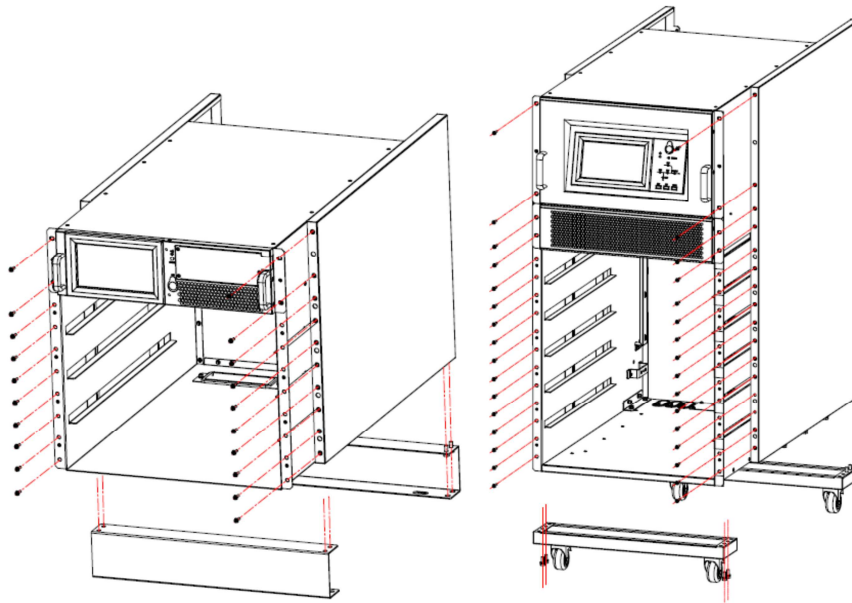
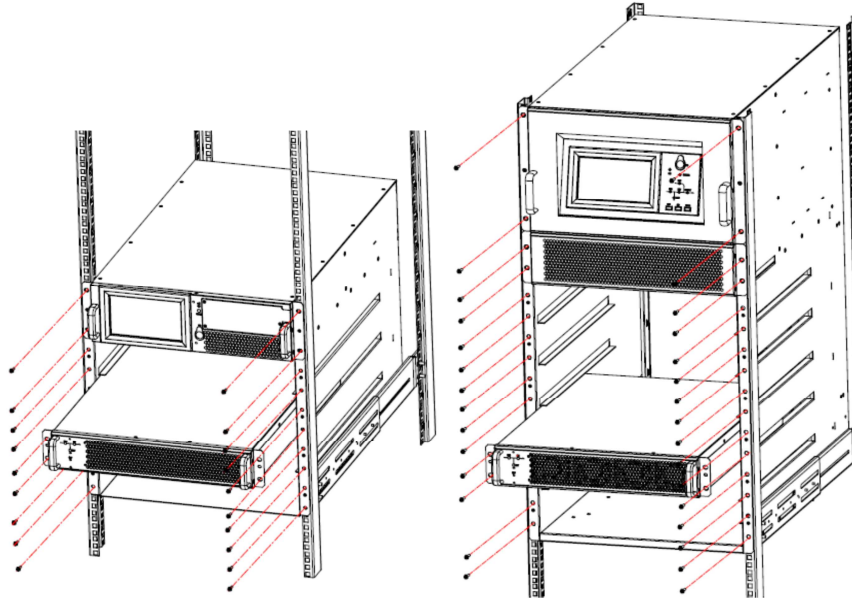

Fig.1- 2: Power Module Installation

When using the UPS in a rack-mount configuration, the UPS must be supported by a slide kit, fixed rails or a shelf. Fasten slide kit into the rack enclosure. Remove side panels and holders of UPS as *Fig.1-3*. Lay the UPS in rack-mounting position. Fasten the UPS into the rack enclosure with (20)M6 screws



(a) Remove side panels and holders



b. fasten cabinet into rack enclosure

Fig.1- 3: rack mounted installation



Warning

Service rack enclosure within side doors should be chosen to cover side panel of UPS cabinet, otherwise the connector for power modules might be touched with tools like screwdriver.

1.4.9 Cable Entry

Cables can enter the module UPS rack system both from bottom and back. The recommended installation practice is to connect cables through ellipse hole to prevent foreign material or vermin entering the cabinet. Use circular entry protector if ellipse hole is not big enough. If connect cables through bottom entry, remove the cover and install a rubber cable protector in the bottom entry hole firstly. Cable entry is followed as *fig.1-4*.

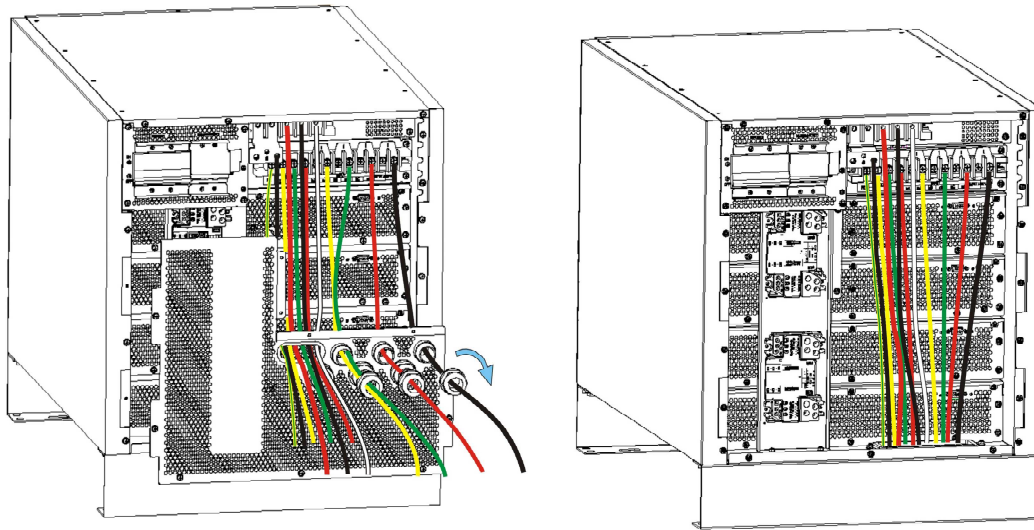

(a) 2-module or 4-module cabinet cables entry

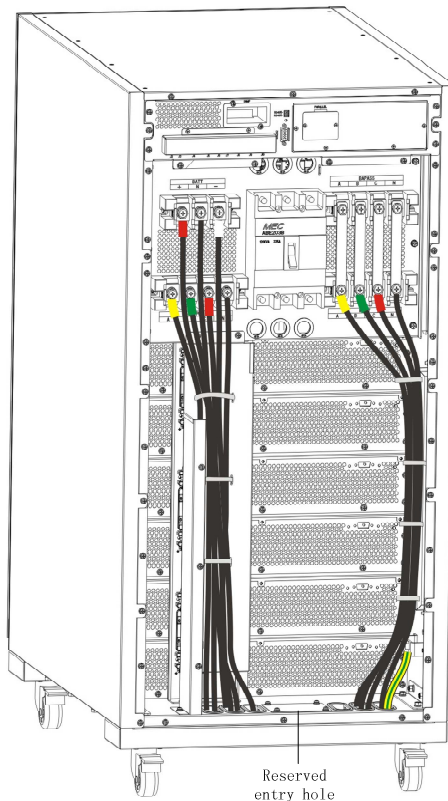

(b) 6-module cabinet cables entry

Fig.1- 4: cable entry



Notes

Cables connection should be followed as diagram on rear panel or *appendix B (2-module and 4-module cabinet)*
 Fix cables in 6-module cabinet as Fig.1-4(b) to make sure best ventilation.
 Enter through reserved entry cover if ellipse holes are not big enough, and block the remained space to protect UPS from rats.

1.5 External Protective Devices

For safety concerns, it is necessary to install external circuit breakers or other protective devices for the input AC supply of the UPS system. This section provides generic practical information for qualified installation engineers. The installation engineers should have the knowledge of the regulatory wiring standards, and of the equipment to be installed.

1.5.1 Rectifier and Bypass Input Supply of the UPS

Over currents

Install suitable protective devices in the distribution unit of the incoming mains supply, considering the power cable current-carrying capacity and overload capacity of the system (*see Tab. 9-7*). Generally, the magnetic circuit breaker with IEC60947-2 tripping curve C (normal) at the 125% of the current listed in Tab. 9-7 is recommended. Split bypass: In case a split bypass is used, separate protective devices should be installed for the rectifier input and bypass input in the incoming mains distribution panel.

Note: *The rectifier input and bypass input must use the same neutral line.*

Protection against earth faults (RCD devices):

The RCD device installed upstream of the input supply should:

Sensitive to DC unidirectional pulses (class A) in the network

Insensitive to transient current pulses

Have an average sensitivity that is adjustable between 0.3A and 1A.

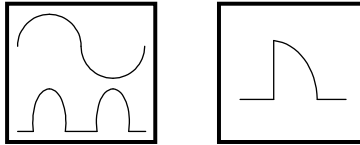

Fig.1- 5: The Symbols of RCCB

When using the RCD in the split bypass system or parallel system, the RCD should be installed in the upstream of the input distribution to avoid wrong alarm.

The residual current introduced by RFI filter in the UPS is between 3.5mA and 1000mA. It is recommended to confirm the sensitivity of each RCD of upstream input distribution and downstream distribution (to load).

1.5.2 External Battery

The DC compatible circuit breaker provides over current protection for UPS system and battery, which is provided by the external battery cabinet.

1.5.3 UPS Output

In the eventuality that an external distribution panel is used for load distribution, the selection of protective devices must provide discrimination with those that are used at the input to the UPS (*see Tab. 9-7*).

1.6 Power Cables

Design the cables according to the descriptions in this section and local regulatory wiring standards, and the environmental conditions (temperature and physical support media) should be taken into consideration. Refer to IEC60950-1 Table 3B Cabling.

 WARNING	
FAILURE TO FOLLOW ADEQUATE EARTHING PROCEDURES CAN RESULT IN EMI, ELECTRIC SHOCK HAZARD, OR RISK OF FIRE, SHOULD AN EARTH FAULT OCCUR.	

Table.1- 2: Maximum Steady State AC and DC Current

UPS power(KVA)	Rated current (A)		
	Main input current at full load battery charging1, 2	Output current at full load2	Battery discharging current at E.O.D=1.67V/cell, no overload

	380V	400V	415V	380V	400V	415V	36 Batt./string	38 Batt./string	40 Batt./string
90	180	180	180	136	130	125	263	249	236
60	120	120	120	92	87	83	175	166	157
45	90	90	90	68	65	62.5	132	125	118
40	80	80	80	61	58	56	117	111	105
30	60	60	60	46	44	42	88	83	79
20	40	40	40	31	29	28	59	56	53
15	30	30	30	23	22	21	44	42	40

Note:

1. Input current of common input configurations of rectifier and bypass
2. Take special care when determining the size of the output and bypass neutral cable, as the current circulating on the neutral cable may be greater than nominal current in the case of non-linear loads, which is usually 1.732 times of rated currents.
3. The earth cable connecting the UPS to the main ground system must follow the most direct route possible. The earth conductor should be sized according to the fault rating, cable lengths, type of protection, etc.
According to AS/IEC60950-1, the cross section area of the conductor is 16mm²/10mm² (30/40/45kVA input/output), the cross section area of the conductor is 10mm²/6mm² (15/20KVA input/output), the cross section area of the conductor is 35mm²/25mm² (60kVA input/output), the cross section area of the conductor is 50mm²/35mm² (90KVA input/output).
4. When sizing battery cables, a maximum volt drop of 4Vdc. is permissible at the current ratings given in Table.1-2. The load equipment is connected to a distribution network of individually protected busbars fed by the UPS output rather than connected directly to the UPS. In parallel multi-module systems, the output cable of each ups rack unit should be kept at equal length between the output of the ups rack output terminals and the parallel distribution busbars to avoid affecting the shared current. When laying the power cables, do not form coils, so as to avoid the formation of electromagnetic interference.
5. See Chapter 4 Installation Drawing for the positions of wiring terminals.

**WARNING**

FAILURE TO FOLLOW ADEQUATE EARTHING PROCEDURES CAN RESULT IN EMI, ELECTRIC SHOCK HAZARD OR RISK OF FIRE, SHOULD AN EARTH FAULT OCCUR.

1.6.1 Cable Connections

**Note**

The operations described in this section must be performed by authorized electricians or qualified technical personnel. If you have any difficulties, do not hesitate to contact our Customer Service & Support department.

After the equipment has been finally positioned and secured, refer to Chapter 4 Installation Drawing to connect the power cables as described in the following procedures:

1. Verify that all the external input distribution switches of the UPS are completely opened and the UPS internal maintenance bypass switch is opened. Attach necessary warning signs to these switches to prevent unauthorized operation.
2. Open rear panel of the UPS, and then the power connection terminals are visible.
3. Connect the protective earth and any necessary grounding cables to the PE terminal. The cabinet for the UPS must be connected to the user's ground connection.

Note: The grounding cable and neutral cable must be connected in accordance with local and national codes practice.

Identify and make power connections for incoming cables according to one of the two procedures below, depending on the type of installation:

Common Input Connections

4. For common bypass and rectifier inputs, connect the AC input supply cables to the UPS input terminals (input A-B-C-N) Refer to Fig. 4-11 and tighten the connections to 5 Nm (M6 Bolt), 13Nm(M8 Bolt) or 25Nm (M10 Bolt). ENSURE CORRECT PHASE ROTATION.

Split Bypass Connections(option)

5. If a 'split-bypass' configuration is used, connect the AC input supply cables to the rectifier input terminals (input A-B-C-N) Refer to Fig.4-11 and the AC bypass supply cables to the bypass input terminals (bypass A-B-C-N) and tighten the connections to 5 Nm (M6 Bolt) or 13Nm (M8 Bolt) or 25Nm (M10 Bolt). ENSURE CORRECT PHASE ROTATION.

Note: For split Bypass operation ensure that the busbars between Bypass and Rectifier inputs are removed. The neutral line of bypass input must be connected to that of the rectifier input.

Frequency Converter Mode

If the frequency converter configuration is used, connect the AC input cables to the rectifier input terminals (input A-B-C-N) Refer to *Fig.4-11* and tighten the connections to 5Nm (M6 bolt), or to 13Nm (M8 bolt), or to 25Nm (M10 bolt). ENSURE CORRECT PHASE ROTATION AND TIGHTEN CONNECTION TERMINALS. No need to connect the bypass input cables to bypass input terminals (bA-bB-bC-bN).

Note: For the frequency converter operation mode, ensure that the busbars between Bypass and Rectifier inputs are removed.

Output System Connections

6. Connect the system output cables between the UPS output busbars (output A-B-C-N) Refer to *Fig.4-11* and the critical load and tighten the connections to 5Nm (M6 Bolt) or to 13Nm (M8 Bolt) or to 25Nm(M10 Bolt). ENSURE CORRECT PHASE ROTATION.



If the load equipment will not be ready to accept power on the arrival of the commissioning engineer, then ensure that the system output cables are safely isolated at their ends.

7. Re-install all the protective covers.

1.7 Control Cabling and Communication

1.7.1 UPS Dry Contactor and Monitoring Board Features

According to the specific needs of the field, the UPS may need auxiliary connection to realize the management of the battery system (including external battery switch and battery temperature sensor), communicate with PC, provide alarm signal to external device, or realize remote EPO. These functions are realized through the UPS dry contactor board (GJ) and monitoring board (JK) at the front of bypass module. The boards provide the following interfaces:

- EPO
- Environment and battery temperature input interface
- Generator input dry contactor interface
- Battery warning output dry contactor interface
- Battery circuit breaker interface
- Mains failure warning output dry contactor interface
- Intellislots (TM) intelligent card interface
- User communication interface

The UPS dry contactor board provides input dry contactors and output dry contactors.

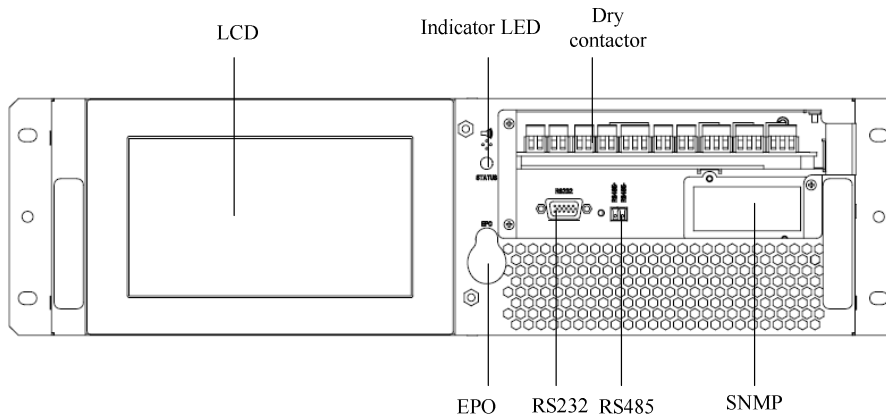

(a) 20kVA/40kVA bypass module

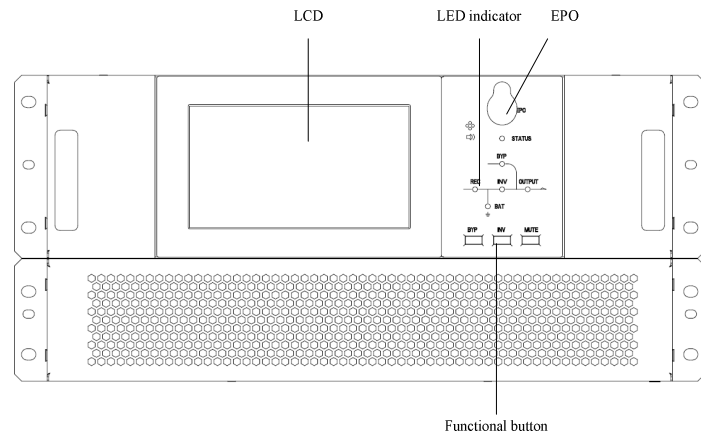

(b) 30kVA/45kVA bypass module

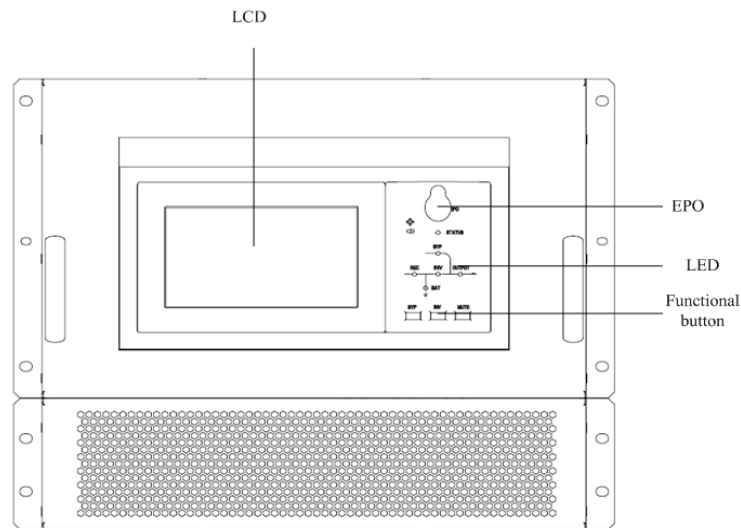

(c) 90kVA bypass module

Fig.1- 6: Bypass Module (include bypass and monitoring)

1.7.2 Dry Contactor Interface of Battery and Environmental Temperature Detection

The input dry contactor J2 and J3 detect the temperature of batteries and environment respectively, which can be used in environment monitoring and battery temperature compensation.

J2 and J3 interfaces diagram are shown in *fig.1-5*, the description of interface is in *table.1-3*.

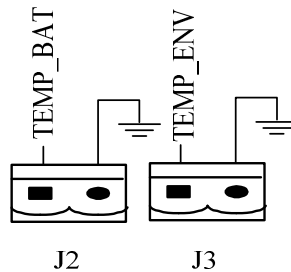

Fig.1- 7: Diagram of J2 and J3 Dry Contactor of Temperature Detection

Table.1- 3: Description of Input Dry Contactor

Position	Name	Purpose
J2.1	TEMP_BAT	Battery temperature detection

J2.2	TEMP_COM	Common terminal
J3.1	TEMP_ENV	Environment temperature detection
J3.2	TEMP_COM	Common terminal
Note: Specified temperature sensor is required for temperature detection (R25=50hm, B25/50=3275), please confirm with the manufacturer, or contactor local maintenance engineers when placing an order.		

1.7.3 Remote EPO Input Port

The UPS has an Emergency Power OFF (EPO) function. This function can be activated by pressing a button on the control panel of the UPS or through a remote contactor provided by the user. The EPO pushbutton is protected by a hinged plastic cover.

J4 is the input port for remote EPO. It requires shorting NC and +24v during normal operation, and the EPO is triggered when opening NC and +24v, or shorting NO and +24v. The port diagram is shown in *fig.1-6*, and port description is shown in *table.1-4*.

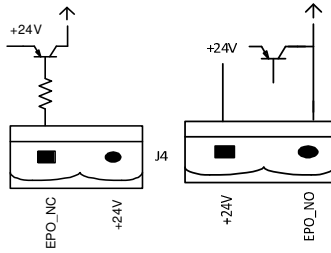

Fig.1- 8: Diagram of Input Dry Contactor for Remote EPO

Table.1- 4: Description of Input Dry Contactor for Remote EPO

Position	Name	Purpose
J4.1	EPO_NC	EPO is activated when disconnecting from J4.2
J4.2	+24V	+24V, connect the common terminal of NC
J4.3	+24V	+24V, connect the common terminal of NO
J4.4	EPO_NO	EPO is activated when shorting with J4.3

The EPO is triggered when shorting pin 3 and 4 or opening pin 1 and 2 of J4.

If an external emergency stop facility is required, it is connected via the reserved terminals of J4. The external emergency stop facility needs to use shielded cables to connect to the normally open/closed remote stop switch between these two pins. If this facility is not used, then pin 3 and pin 4 of J4 must be open, or pin 1 and pin 2 of J4 must be shorted.

⚠
Note
<ol style="list-style-type: none"> 1. The emergency stop action within the UPS will shut down the rectifier, inverter and static bypass. However, it does not internally disconnect the mains input power supply. To disconnect ALL power to the UPS, open the upstream input circuit breaker(s) when the EPO is activated. 2. Pin 1 and 2 of J4 have been shorted before the UPS is delivered. 3. All auxiliary cables must be double insulated twisted cables with cross sectional area of 0.5mm² ~ 1.5mm² for maximum connection length between 25m and 50m.

1.7.4 Generator Input Dry Contactor

J5 is the status interface for generator connection. Connect J5-2 with J5-1, it indicates that the generator has been connected with the system. The interface diagram is shown in *fig.1-7*, and interface description is shown in *table.1-5*.

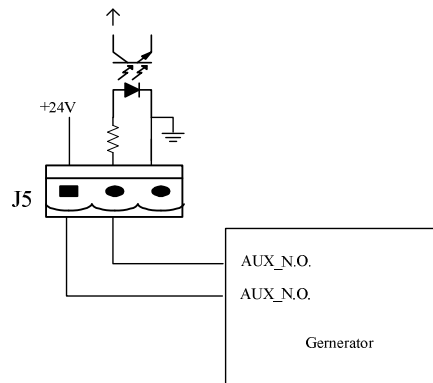

Fig.1- 9: Connection of Generator

Table.1- 5: Description of Status Interface and Connection of Generator

Position	Name	Purpose
J5.1	+24V	Internal +24V power supply
J5.2	GEN	Connection status of generator
J5.3	GND	Power ground

**Note**

All auxiliary cables must be double insulated twisted cables with cross sectional area of 0.5mm² ~ 1.5mm² for maximum connection length between 25m and 50m.

1.7.5 BCB Input Port

J6 and J7 are the ports of BCB. The diagram is shown in *fig.1-8*, and description is shown in *table.1-6*.

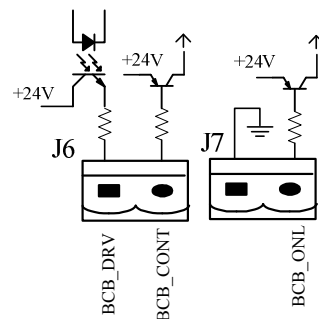

Fig.1- 10: BCB Interface

Table.1- 6: Description of BCB Interface

Position	Name	Description
J6.1	BCB_DRV	BCB actuating signal, provide the actuating signal of +24V, 20mA
J6.2	BCB_CONT	BCB contactor status, connect with the normally open signal of BCB
J7.1	GND	Common connection
J7.2	BCB_ONL	BCB on-line-input (normally open) , BCB is on-line when the signal is connecting with common connection

**Note**

All auxiliary cables must be double insulated twisted cables with cross sectional area of 0.5mm² ~ 1.5mm² for maximum connection length between 25m and 50m.

1.7.6 Battery Warning Output Dry Contactor Interface

J8 is the output dry contactor interface, which outputs the battery warnings of low or excessive voltage, when the battery voltage is

lower than set value, an auxiliary dry contactor signal will be provided via the isolation of a relay. The interface diagram is shown in *fig.1-9*, and description is shown in *table.1-7*.

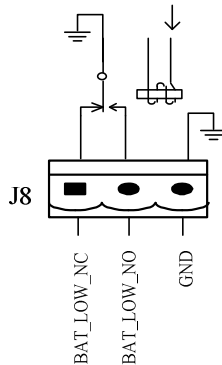

Fig.1- 11: Battery Low Warning Dry Contactor

Table.1- 7: Battery warning dry contactor interface description

Position	Name	description
J8.1	BAT_LOW_NC	Battery warning relay (normally closed) will be open during warning
J8.2	BAT_LOW_NO	Battery warning relay (normally open) will be closed during warning
J8.3	GND	Common connection

1.7.7 Integrated Warning Output Dry Contactor Interface

J9 is the integrated warning output dry contactor interface, when one or more than one present warning is triggered, the system will send an integrated warning information, and provide an auxiliary dry contactor signal via the isolation of a relay. The interface diagram is shown in *fig.1-10*, and description is shown in *table.1-8*.

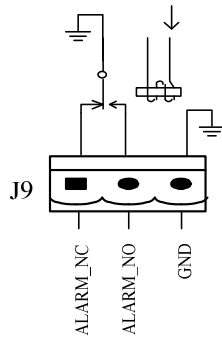



Fig.1- 12: Integrated warning dry contactor

Table.1- 8: Integrated warning dry contactor interface description

Position	Name	Purpose
J9.1	ALARM_NC	Integrated warning relay (normally closed) will be open during warning
J9.2	ALARM_NO	Integrated warning relay (normally open) will be closed during warning
J9.3	GND	Common connection
 Note		
All auxiliary cables must be double insulated twisted cables with cross sectional area of 0.5mm ² ~ 1.5mm ² for maximum connection length between 25m and 50m.		

1.7.8 Mains Failure Warning Output Dry Contactor Interface

J10 is the output dry contactor interface for utility failure warning, when the utility fails, the system will send a utility failure warning information, and provide an auxiliary dry contactor signal via the isolation of a relay. The interface diagram is shown in *fig.1-11*, and description is shown in *table.1-9*.

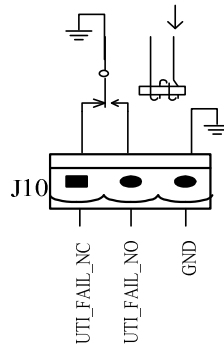

Fig.1- 13: Utility Failure Warning Dry Contactor

Table.1- 9: Description of Mains failure warning dry contactor

Position	Name	Purpose
J10.1	UTL_FAIL_NC	Mains failure warning relay(normally closed) will be open during warning
J10.2	UTL_FAIL_NO	Mains failure warning relay (normally open) will be closed during warning
J10.3	GND	Common connection



Note

All auxiliary cables must be double insulated twisted cables with cross sectional area of 0.5mm² ~ 1.5mm² for maximum connection length between 25m and 50m.



Note

Connect dry contactor cables as *Fig.4-12*

Chapter 2 Battery Installation and Maintenance

2.1 General Recommendations

Take special care when operating the batteries of the Modular UPS system. When all the battery cells are connected, the battery voltage can exceed 400Vdc, which is potentially lethal.



Note

The precautions for battery installation, use and maintenance are to be provided by the batteries manufacturers. The precautions in this section include the key issues that must be considered during the installation design, which may be adjusted according to the specific local situations.



Battery Room Design

- The battery shall be installed and stored in a clean, cool and dry environment.
- Do not install the battery in a sealed battery chamber or sealed room. The battery room ventilation shall at least meet the requirement of EN50272-2001. Otherwise, battery bulging, fire and even human injury may be caused.
- The battery shall be installed far away from the heating source (e.g. transformer). Do not use or store the battery in the place near the heating source or burn the battery or place it into fire. Otherwise, battery leakage, bulging, fire or explosion may be caused.
- Batteries shall be placed in such a manner that two bare live parts with the potential difference of more than 150V shall not be contactored at the same time. If it is unavoidable, insulated terminal cover and insulated cables shall be used for connection.
- If external batteries are to be used, the battery circuit breakers (or fuses) must be mounted as close as possible to the batteries, and the connecting cables should be as short as possible.



Battery Handling

When connecting the battery, follow the precautions for high-voltage operation

- Before accepting and using the battery, check the appearance the battery. If the package is damaged, or the battery terminal is dirty, corroded or rusted or the shell is broken, deformed or has leakage, replace it with new product. Otherwise, battery capacity reduction, electric leakage or fire may be caused.
 - Before operating the battery, remove the finger ring, watch, necklace, bracelet and any other metal jewelry
 - Wear rubber gloves.
 - Eye protection should be worn to prevent injury from accidental electrical arcs.
 - Only use tools (e.g. wrench) with insulated handles.
- The batteries are very heavy. Please handle and lift the battery with proper method to prevent any human injury or damage to the battery terminal.
- Do not decompose, modify or damage the battery. Otherwise, battery short circuit, leakage or even human injury may be caused.
- The battery contains sulfuric acid. In normal operation, all the sulfuric acid is attached to the separation board and plate in the battery. However, when the battery case is broken, the acid will leak from the battery. Therefore, be sure to wear a pair of protective glasses, rubber gloves and skirt when operating the battery. Otherwise, you may become blind if acid enters your eyes and your skin may be damaged by the acid.
- At the end of battery life, the battery may have internal short circuit, drain of electrolytic and erosion of positive/negative plates. If this condition continues, the battery may have temperature out of control, swell or leak. Be sure to replace the battery before these phenomena happen.
- If a battery leaks electrolyte, or is otherwise physically damaged, it must be replaced, stored in a container resistant to sulfuric acid and disposed of in accordance with local regulations.
- If electrolyte comes into contactor with the skin, the affected area should be washed immediately with water.

2.2 Battery Typologies

According to the requested configuration UPS may need batteries consisting of one or more strings of battery blocks installed on shelves in a locked cabinet or dedicated battery room

 Note
<p>The Traditional external battery cabinet can make use of each even number of battery per string between 36 and 44. The default factory setting, if the unit is ordered w/o internal battery is 40. The cabinet is only for valve regulated maintenance-free lead-acid battery. CAUTION: The lead acid battery may cause chemistry hazard</p>

2.2.1 Traditional Battery Installation

Only the qualified engineers are allowed to install and maintain mounted in a traditional battery cabinet or shelf. To ensure safety, install the external battery in a locked cabinet or dedicated battery room accessible just to service qualified personnel.

Please note that number of cells set via software must be consistent with the actual number of cells.

A minimum space of 10mm must be reserved on all vertical sides of the battery block to permit free air movement around the cells.

A certain clearance should be reserved between the top of the cells and the underside of the shelf above as this is necessary for monitoring and servicing the cells.

When installing the batteries always work from the bottom shelf upwards to prevent raising the center of gravity.

Install the batteries reliably and avoid vibration and mechanical bumping.

The bending radius of cable should be more than 10D, where "D" is the outer diameter of cable.

When connecting the cable, do not cross the battery cables and do not bind the battery cables together. The battery connection must be firm and reliable. After the connection, all the connections between the wiring terminals and the batteries must be corrected to meet the torque requirement provided in the specifications and user manuals of the battery manufacturers.

Each battery terminal should be insulated after its connection has been made.

Check if the battery is unexpectedly grounded. If the battery is unexpectedly grounded, remove the earth power supply. Contacting any part of the grounded earth may be subject to electric shock.

Measure the battery voltage, and carry out battery voltage calibration after the UPS is started.

Diagram of batteries connection is shown as below:

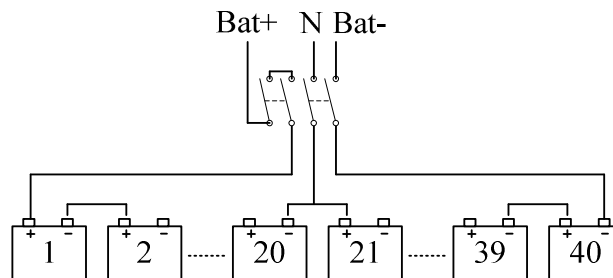



Fig.2- 1: Diagram of Batteries Connection

  Warning: Battery connections
<p>When using a traditional battery solution, always comply with the following precautions:</p> <ul style="list-style-type: none"> ● Disconnect the charging power before connecting or disconnecting the cable of the battery terminals. ● Do not connect the cables between the UPS battery terminals and the batteries before getting the approval from the commissioning engineer. ● When connecting the cables between the battery terminals and the circuit breaker, always connect the circuit breaker end of the cable first. ● Be sure to connect the positive/negative terminals of the batteries to those of the circuit breakers and those of the circuit breakers to those of the UPS respectively with reference to the markings of positive/negative terminals. Reverse connection of battery polarities will result in explosion, fire accident, the damage of batteries and UPS, and human injury. ● The battery connecting terminal shall not subject to any external force, such as the pulling force or twisting force of the cable. Otherwise, the internal connection of the battery may be damaged, and in severe case, the battery may catch fire.

- Do not connect power until the total voltage of the battery string is verified correct through measurement.
- Do not connect any conductor between the positive and negative terminals of the battery.
- Do not close the battery circuit breakers before getting the approval from the commissioning engineer.

2.3 Battery Maintenance

For the battery maintenance and precautions, please refer to IEEE-Std-1188-2005 and the relevant manuals provided by the battery manufacturers.



Battery Maintenance Note

- Check to ensure that all the safety devices are in place and function normally. Check if the battery management parameter setting is normal particularly.
- Measure and record the air temperature in the battery room.
- Check if the battery terminals are damaged or have the symptom of heating, and if the shell or cover is damaged.
- Please fasten every bolt on the terminal according to the fastening torque specified in the table below.
- After 1-2 months of service, recheck to make sure that each screw has been fastened according to the specified torque. Otherwise there is risk of fire.
- **CAUTION:** Use the battery with the same capacity and type, if battery is replaced by an incorrect type, it can cause explosion.
- **CAUTION:** Dispose of used battery according to the local instructions

Chapter 3 Installation of UPS Rack System

3.1 Overview

The single system should be installed according to the installation procedures of the UPS rack module system and the requirements in this Chapter.

For single UPS rack module installation the EPO button on the front panel of the UPS rack controls the emergency stop of UPS modules and bypass static switch and also supports remote emergency power off function that can be used to shut down the UPS rack module remotely.

 Note
1. The remote EPO switch must provide normally open or normally closed dry contactor signals.
2. The open circuit voltage is 24Vdc, and the current is less than 20mA.
3. Normally closed EPO-J4 terminals: Pin 1 and pin 2 have been connected in factory and located on the dry contactor board.
4. Set EPO function as available with monitoring software on PC before using remote EPO function.

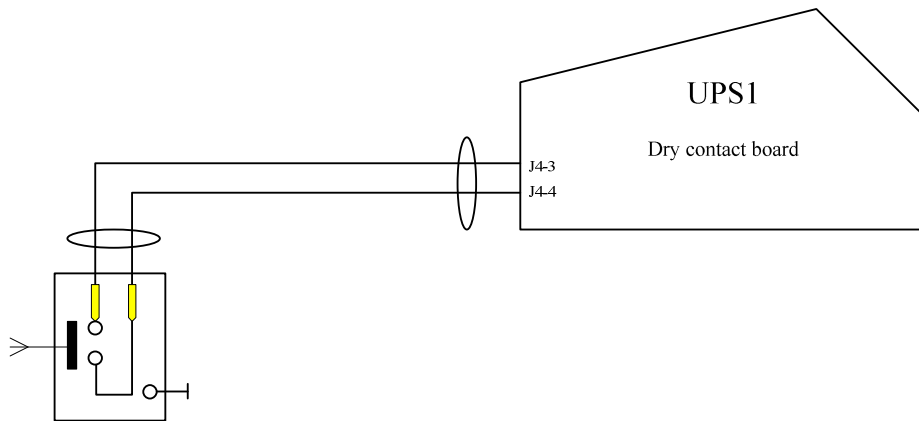

(a) Single unit

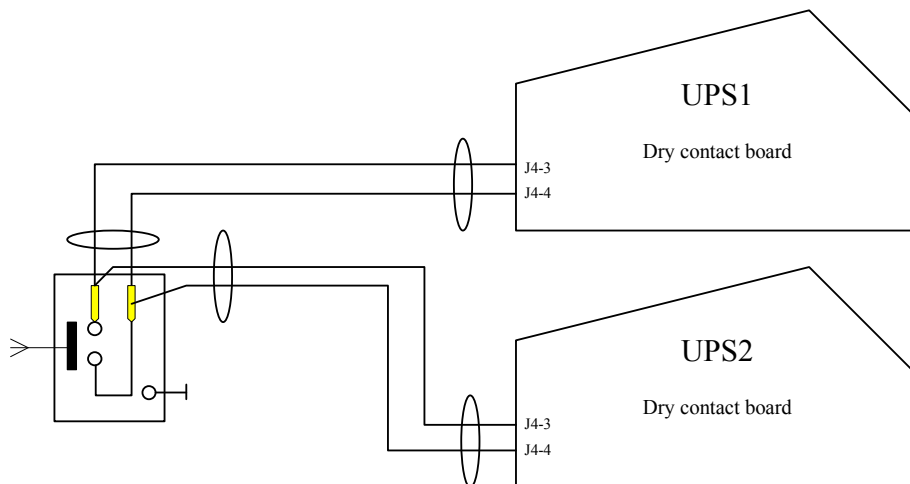

(b) Parallel system

Fig.3- 1: Circuit diagram of EPO

3.2 UPS Rack Modules in Parallel System

The basic installation procedures of parallel system are the same with those of the UPS rack module system. In this section, only the installation procedures related to the parallel system are introduced.

3.2.1 Installation of Cabinet

To make the maintenance and system test easier, an external maintenance bypass is recommended in the installation.

3.2.2 External Protective Devices

Refer to *Chapter 1 Installation*

3.2.3 Power Cables

The power cable connection of the parallel rack module system is similar to that of the single UPS rack module system. If the bypass input and rectifier input share the same neutral terminal and if an RCD protective device is installed at the input, then the RCD device must be installed before the input cables are connected to the neutral terminal. Refer to Chapter 1 Installation

Note: The length and specification of the power cables of each UPS module should be the same, including the bypass input cables and UPS output cables, so that the load sharing effect can be achieved in bypass mode.

3.2.4 Parallel Signal Board

Installation of parallel signal board

The parallel signal board is installed at the rear of the cabinet. Shown as below:

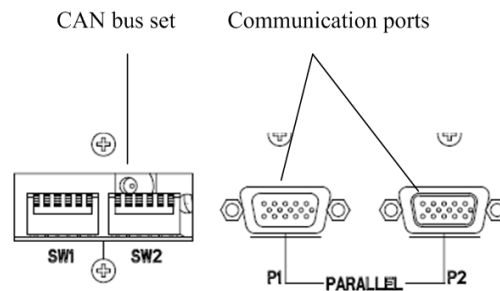

Fig.3- 2: Parallel Board

3-slots cabinet and 6-slots cabinet:

The switches SW1 and SW2 on the UPS should be set as below:

(S) Single- all switches ON

P(2) 2 paralleled- switch SW1 ON, switch SW2 OFF

P(3/4/5) 3 paralleled, 4 paralleled, 5 paralleled- all switches OFF

2-slots cabinet and 4-slots cabinet:

No need to modify CAN bus setting.

3.2.5 Control Cables

Parallel control cable

The parallel control cables are designed to be shielded and double insulated, DB15 terminals, and are connected between the UPS rack modules to form a loop as shown below. The parallel signal board is installed at the rear of the cabinet. This close loop connection ensures the reliability of the parallel system control. Refer to *fig. 3-3*

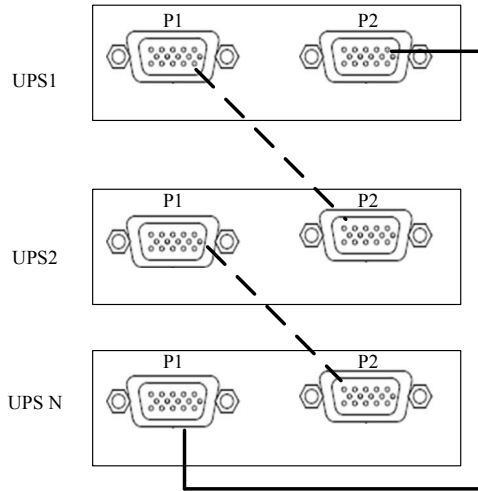

Fig.3- 3: Connection of Parallel Cables of "1+N" System

Chapter 4 Installation Drawing

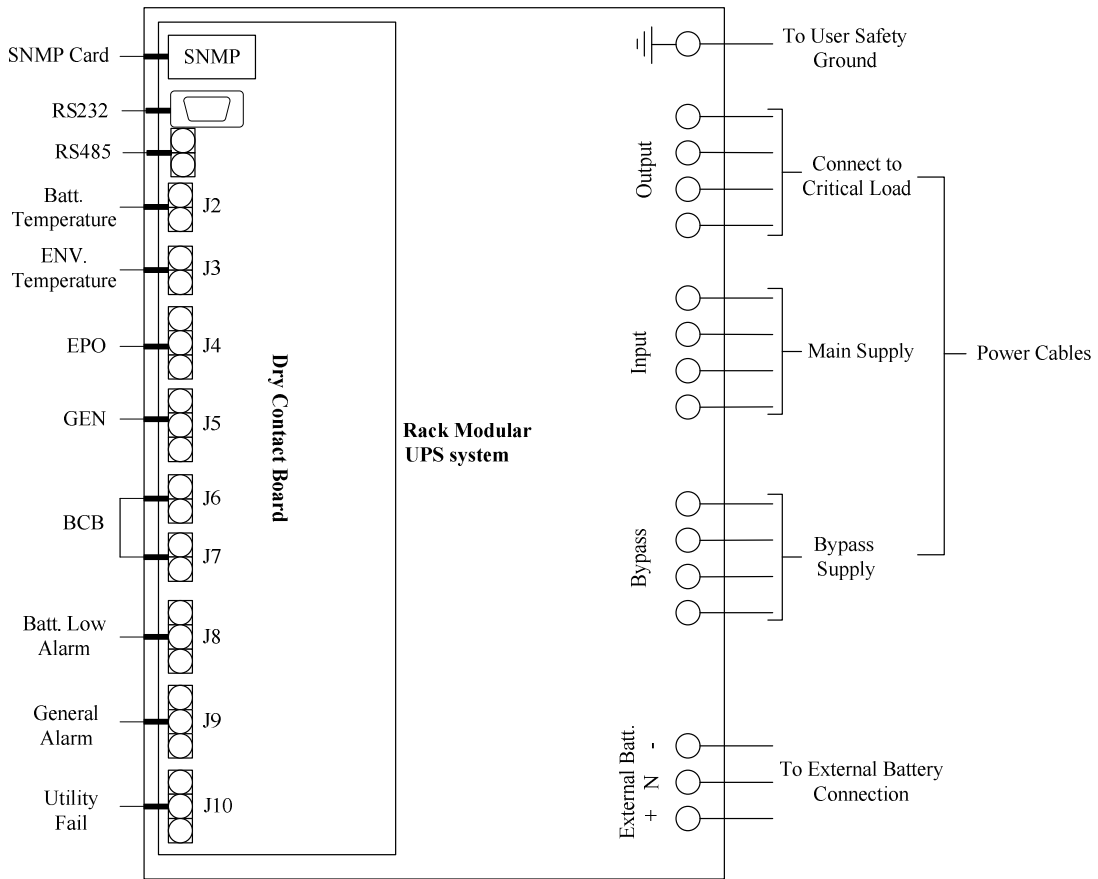

Fig.4- 1: Wiring Diagram

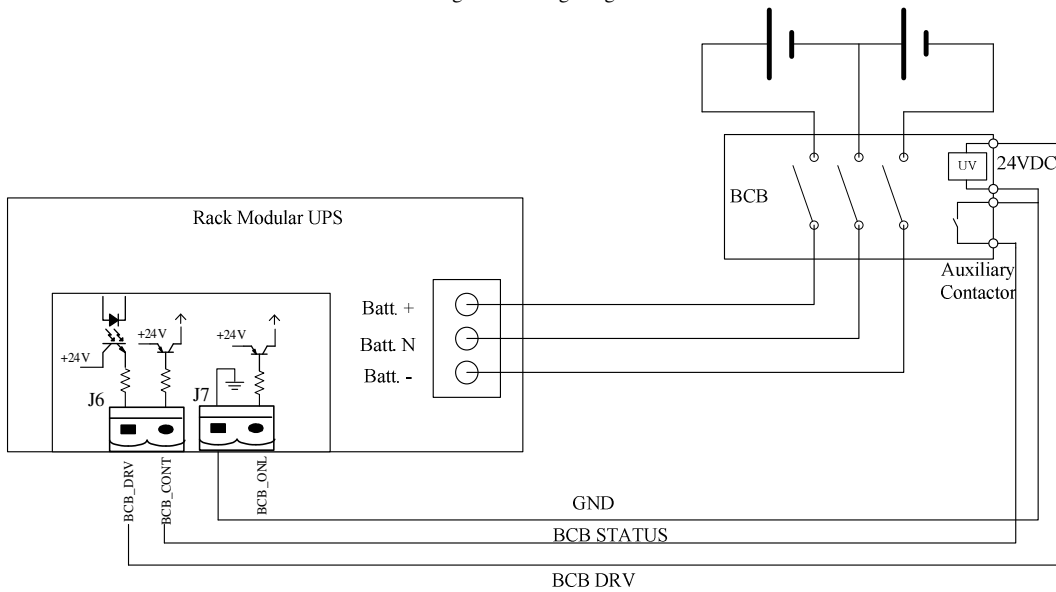

Fig.4- 2: External Battery Connection

- External BCB interface:
 BCB DRV: J6-1 BCB drive signal
 BCB STATUS: J6-2 BCB contactor status, normally opened. Shorted to GND when activated
 GND: J7-1 ground

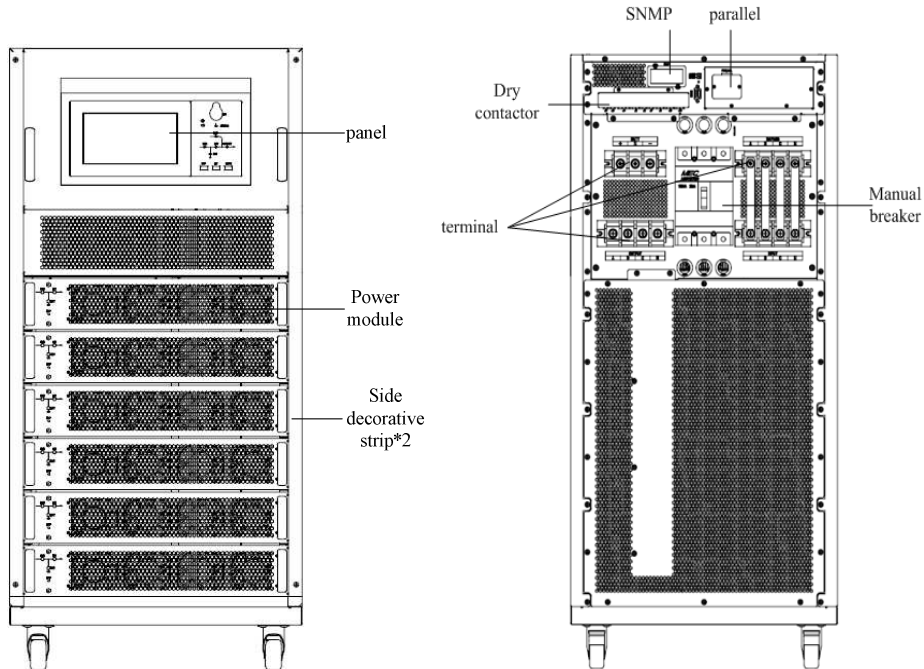

Fig.4- 3: 6 modules UPS System, Front View and Rear View without Door

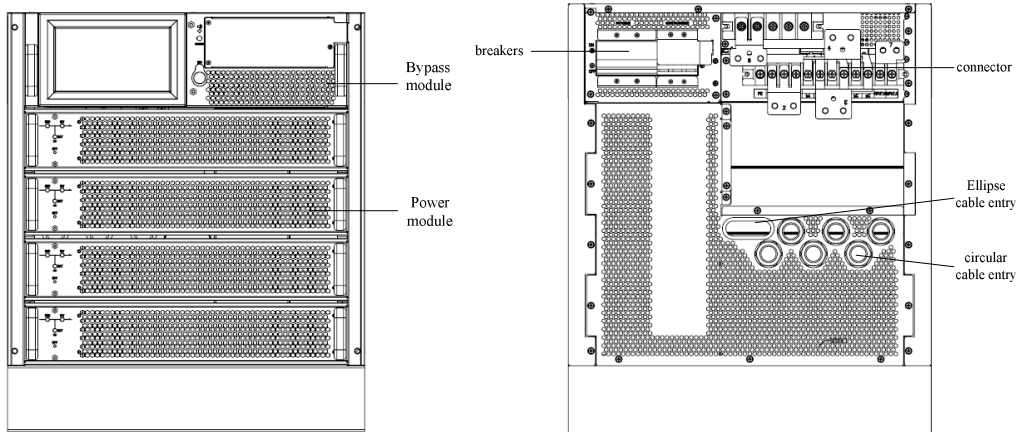

Fig.4- 4: 4 Modules UPS System, Front View and Rear View without Door

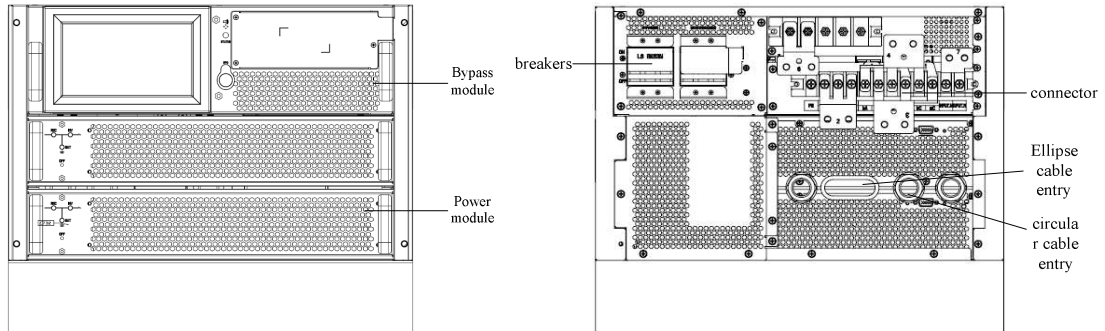

Fig.4- 5: 2 Modules UPS System, Front View and Rear View without Door

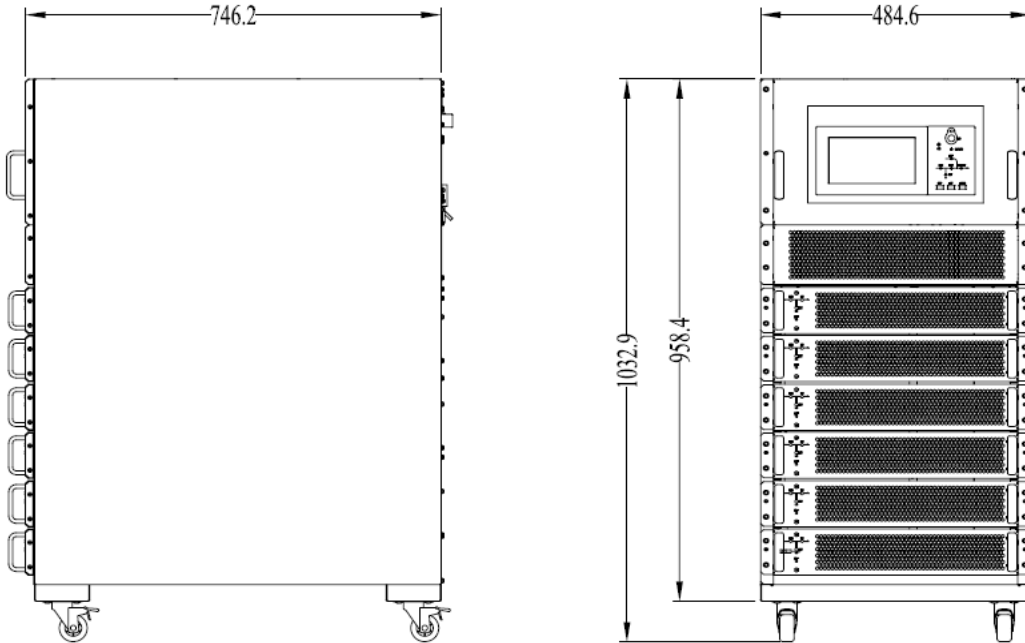

Fig.4- 6: 6 Modules UPS External Dimensions

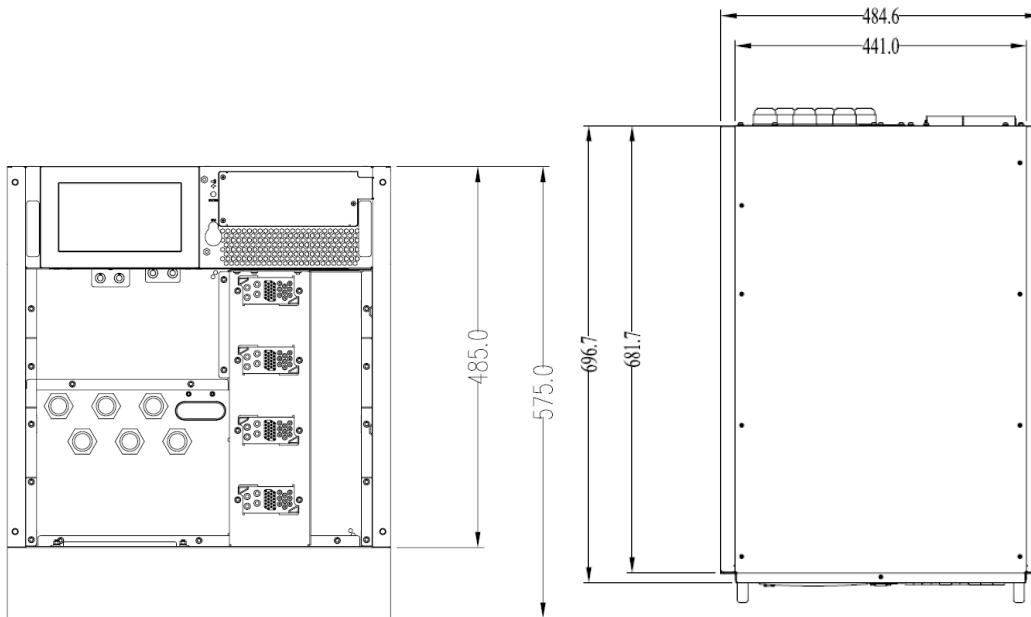

Fig.4- 7: 4 Modules UPS External Dimensions

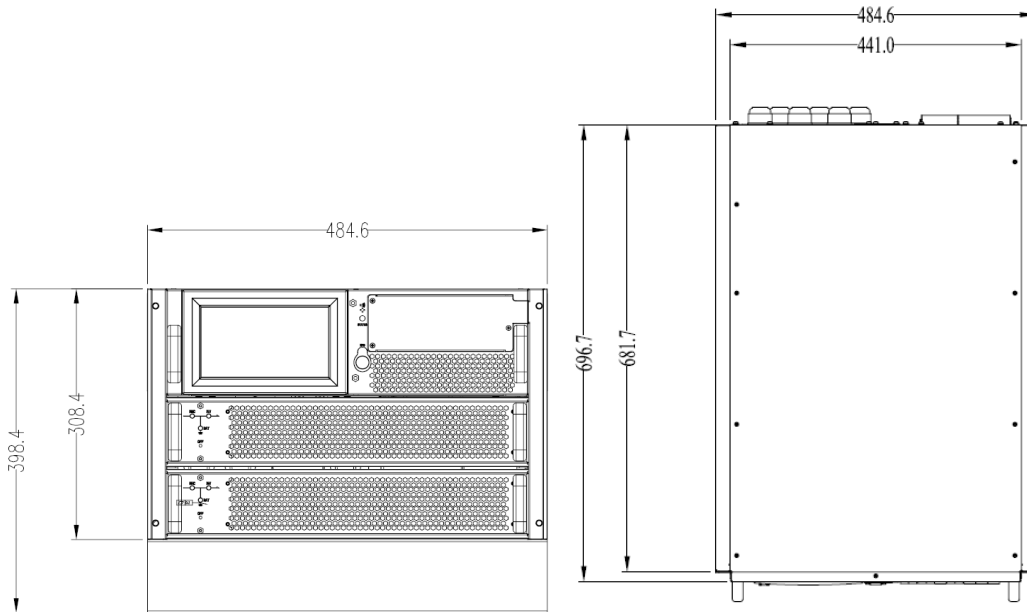
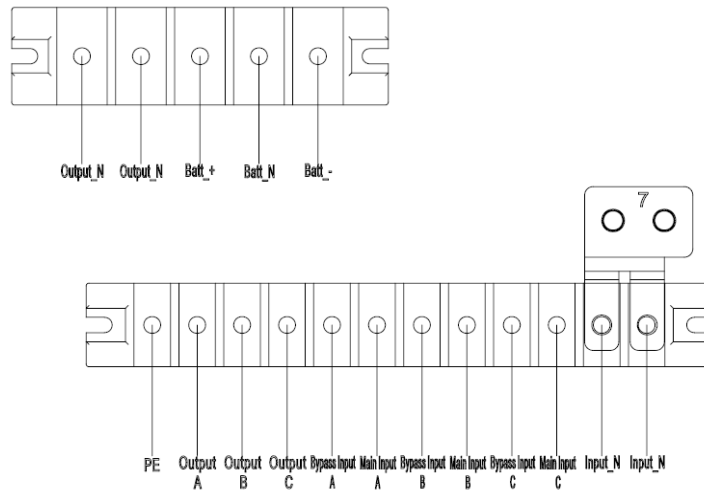
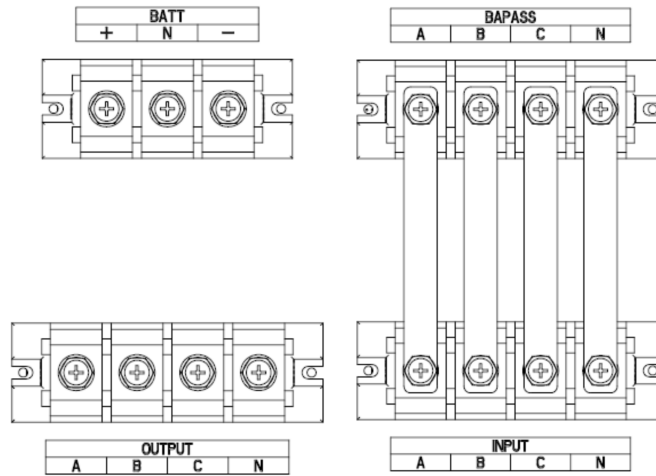

Fig.4- 8: 2 Modules UPS External Dimensions



(a) 20KVA/40KVA power connection



(b) 60KVA/90KVA power connection

Fig.4- 9: Power Connection of Module System UPS

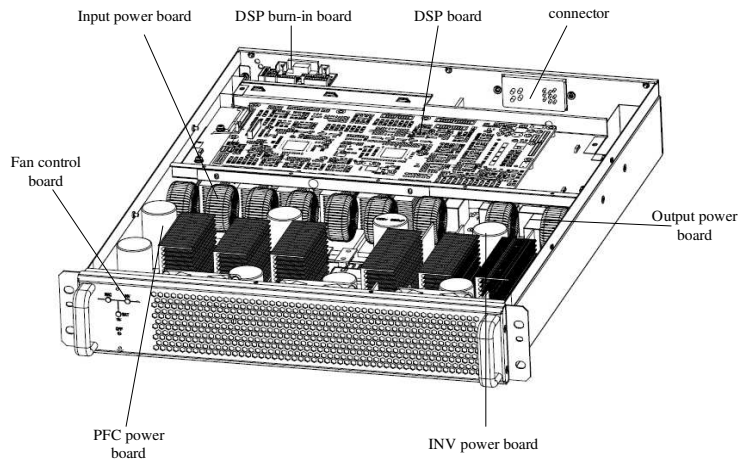
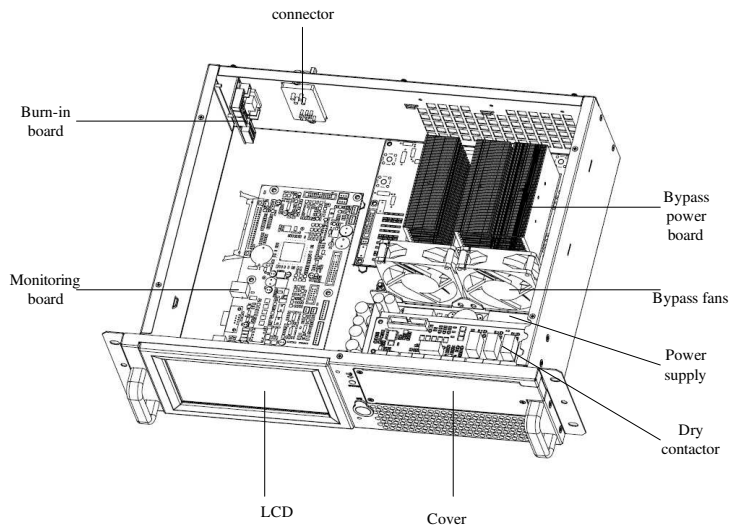
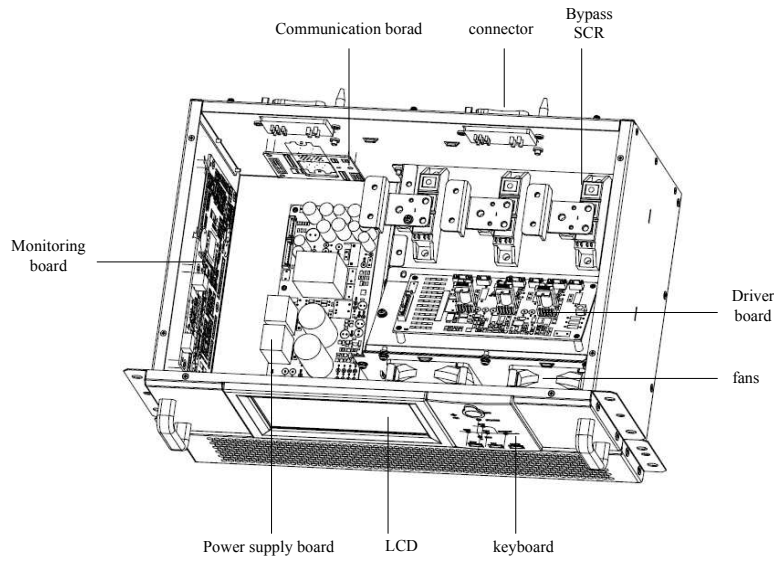

Fig.4- 10: Power Module



(a) 20KVA/40KVA Bypass Module



(b) 30kVA/45KVA bypass module

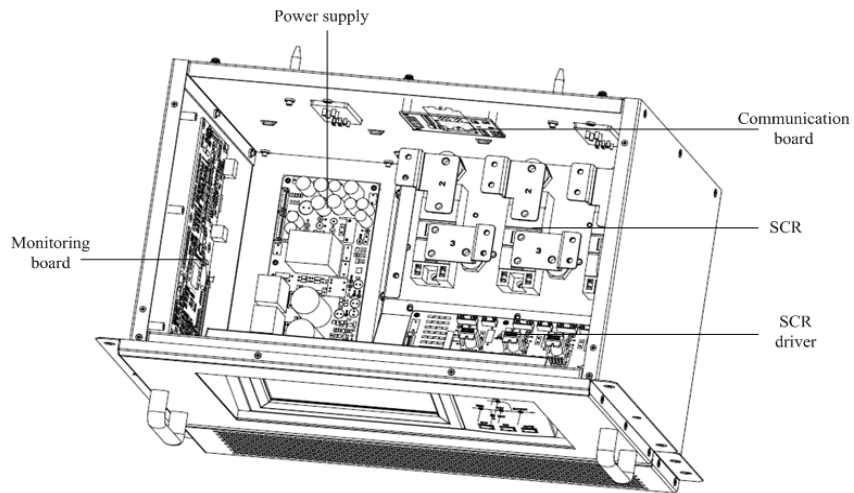

(c) 60KVA/90KVA Bypass Module

Fig.4- 11: Monitoring and Bypass Module

Notes for installing modules:

1. When installing the modules, install the modules from bottom to top. When removing the modules, remove the modules from top to bottom. The purpose is to maintain the stable center of gravity.
2. After inserting the module, tighten all the screws.
3. When removing the modules, turn off modules first, remove the screws and then remove the modules.
4. Wait for 5 minutes before inserting the removed modules.

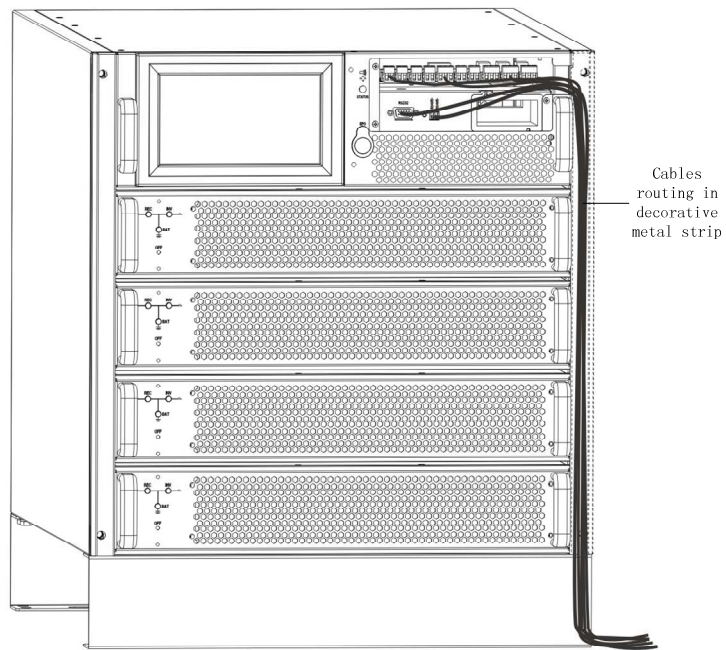

Fig.4- 12: cables routing (dry contactor, RS485, SNMP)

Notes for signal cables routing:

1. Remove cover on front panel and remove right metal strip
2. Connect cables and route as Fig.4-12
3. Cover right metal strip back to UPS to cover the cables

Chapter 5 Operations



Warning: Hazardous mains voltage and/or battery voltage present(s) behind the protective cover

The components that can only be accessed by opening the protective cover with tools cannot be operated by user. Only qualified service personnel are authorized to remove such covers.

5.1 Introduction

The Modular UPS rack system provides the critical load (such as communication and data processing equipment) with high quality uninterruptible AC power. The power from the UPS is free from voltage and frequency variations and disturbances (interruption and spike) experienced at the Mains AC input supply.

This is achieved through high frequency double conversion power pulse width modulation (PWM) associated with fully digital signal processing control (DSP), which features high reliability and convenience for use.

As shown in *fig.5-1*, the AC input mains source is supplied at UPS input and converted into a DC source. This DC source feeds the Inverter that converts the DC source into a clean and input independent AC source. The battery powers the load through the inverter in case of an AC input mains power failure. The utility source can also power the load through the static bypass.

When the UPS needs maintenance or repair, the load can be transferred to maintenance bypass without interruption and the power module and bypass module can be removed for maintenance.

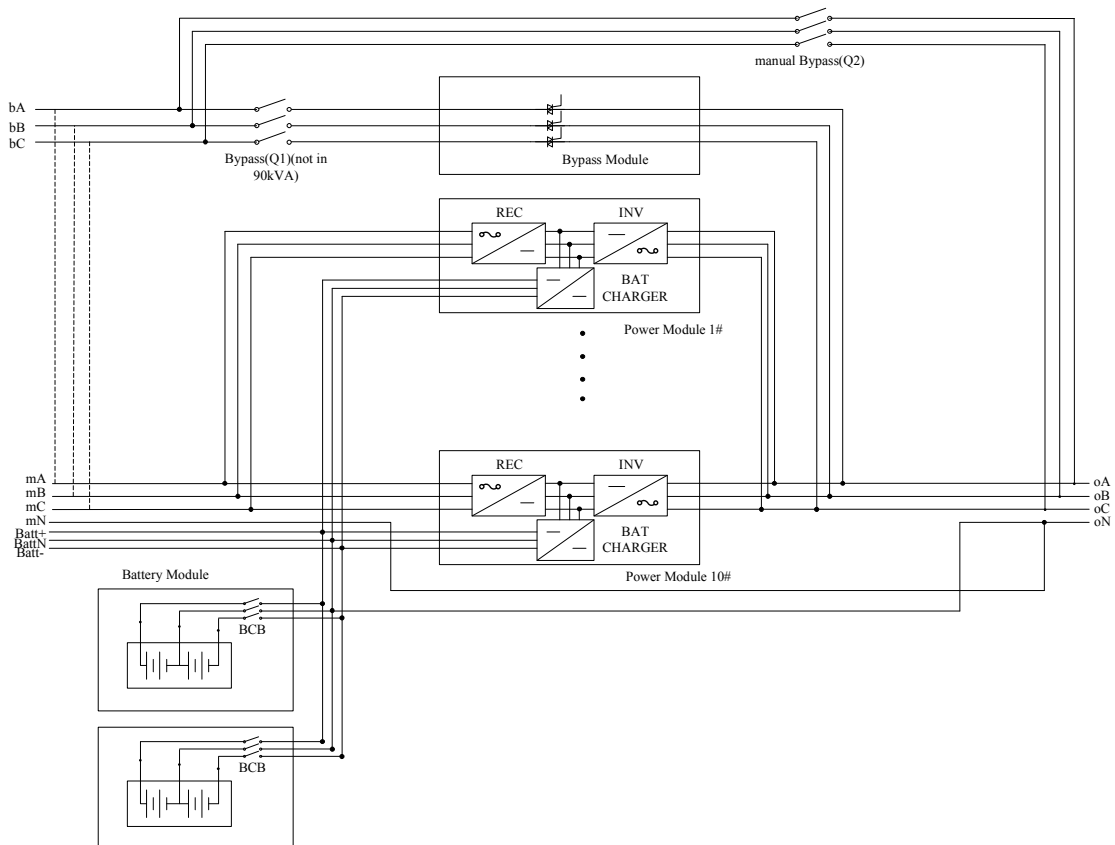

Fig.5- 1: Single Unit Block Diagram

5.1.1 Split-Bypass Input

Fig. 5-1 illustrates the Modular UPS in what is known as the split-bypass configuration (that is, the bypass uses a separated AC power).

In this configuration, the static bypass and maintenance bypass share the same independent bypass power supply and connect to the power supply through a separate switch. Where a separated power source is not available, the bypass and rectifier input supply connections are linked.

5.1.2 Static Transfer Switch

The circuit blocks labeled Static Switch in *fig.5-1* contain electronically controlled switching circuits that enable the critical load to be connected to either the inverter output or to a bypass power source via the static bypass line. During normal system operation the load is connected to the inverter; but in the event of a UPS overload or inverter failure, the load is automatically transferred to the static bypass line. To provide a clean (no-break) load transfer between the inverter output and static bypass line, the inverter output and bypass supply must be fully synchronized during normal operating conditions. This is achieved through the inverter control electronics, which makes the inverter frequency track that of the static bypass supply, provided that the bypass remains within an acceptable frequency window.

A manually controlled maintenance bypass supply is incorporated into the UPS design. It enables the critical load to be powered from the utility (bypass) supply while the UPS is shut down for routine maintenance.

 Note
When the UPS is operating in bypass mode or on maintenance bypass, the connected equipment is not protected from power failures or surges and sags.

5.2 1+1 Parallel System

Several “single unit” UPS modules may constitute a “1+1” system, where up to two single units operate together for the purpose of providing additional power or reliability or both. The load is equally shared between any paralleled UPSs.

5.2.1 Features of Parallel System

1. The hardware and firmware of single module UPS units are completely compatible with the requirements of a parallel system. Parallel configuration can be achieved merely through settings in configuration software. The parameters settings for the modules in parallel system shall be consistent.
2. Parallel control cables are connected in a ring, providing both performance and redundancy. Dual-bus control cables are connected between any two UPS modules of each bus. The intelligent paralleling logic provides the user with maximum flexibility. For example, shutting down or starting up UPS modules in a parallel system can be done in any sequence. Transfers between Normal and Bypass modes of operation are synchronized and self-recovering e.g. following overloads and their clearance.
3. The total load of the parallel system can be queried from each unit’s LCD.

5.2.2 Parallel Requirements of UPS Modules

A group of paralleled modules behave as if it were one large UPS with the advantage of presenting higher reliability. In order to assure that all modules are equally utilized and to comply with relevant wiring rules, the following requirements apply:

1. All UPS modules shall be of the same rating and must be connected to the same bypass source.
2. The bypass and the main input sources must be referenced to the same neutral potential.
3. Any RCD (Residual Current detecting device), if installed, must be of an appropriate setting and located upstream of the common neutral bonding point. Alternatively, the device must monitor the protective earth currents of the system. Refer to the High Leakage Current Warning in the first part of this manual.
4. The outputs of all UPS modules must be connected to a common output bus.
5. It is strongly recommended that each paralleled UPS install at least a redundant power module

 Note
1. Optional isolation transformers are available for applications where sources do not share the same neutral reference or where the neutral is not available.

5.3 Operating Mode

The Modular UPS is an on-line, double-conversion, reverse-transfer UPS that permits operation in these modes:

- Normal mode
- Battery Mode
- Auto-restart mode
- Bypass mode
- Maintenance mode (manual bypass)
- Parallel redundancy mode(6 modules cabinet)
- ECO Mode

5.3.1 Normal Mode

The UPS inverter power modules continuously supplies the critical AC load. The rectifier/charger derives power from the AC mains input source and supplies DC power to the inverter while simultaneously FLOAT or BOOST charging its associated backup battery.

5.3.2 Battery Mode

Upon failure of the AC mains input power; the inverter power modules, which obtains power from the battery, supplies the critical AC load. There is no interruption in power to the critical load upon failure. After restoration of the AC mains input power, the “Normal Mode” operation will continue automatically without the necessity of user intervention.

5.3.3 Auto-Restart Mode

The battery may become exhausted following an extended AC mains failure. The inverter shuts down when the battery reaches the End of Discharge voltage (EOD). The UPS may be programmed to “Auto Recovery after EOD” after a delay time if the AC mains recovers. This mode and any delay time are programmed by the commissioning engineer.

5.3.4 Bypass Mode

If the inverter overload capacity is exceeded under normal mode, or if the inverter becomes unavailable for any reason, the static transfer switch will perform a transfer of the load from the inverter to the bypass source, with no interruption in power to the critical AC load. Should the inverter be asynchronous with the bypass, the static switch will perform a transfer of the load from the inverter to the bypass with power interruption to the load. This is to avoid large cross currents due to the paralleling of unsynchronized AC sources. This interruption is programmable but typically set to be less than 3/4 of an electrical cycle, e.g., less than 15ms (50Hz) or less than 12.5ms (60Hz).

5.3.5 Maintenance Mode (Manual Bypass)

A manual bypass switch is available to ensure continuity of supply to the critical load when the UPS becomes unavailable e.g. during a maintenance procedure.

5.3.6 Parallel Redundancy Mode (System Expansion)

For higher capacity or higher reliability or both, the outputs of several UPS modules can be programmed for direct parallel while a built-in parallel controller in each UPS ensures automatic load sharing.

5.3.7 Eco Mode

To improve system efficiency, UPS rack system works in bypass mode at normal time, and inverter is standby. When utility fails, UPS transfer to battery mode, and inverter power the loads. The efficiency of ECO system can be up to 98%.

NOTE: There is a short interruption time (lower than 10ms) when transfer from ECO mode to battery mode, it must be sure that the time has no effect on loads.

5.4 Battery Management—Set During Commissioning

5.4.1 Normal Function

1. Constant Current Boost Charging

Current can be set up as 0%~20%, default setting is 10%.

2. Constant Voltage Boost Charging

Voltage of boost charging can be set as required by the type of battery.

For Valve Regulated Lead Acid (VRLA) batteries, maximum boost charge voltage should not exceed 2.4V / cell.

3. Float Charge

Voltage of float charging can be set as required by the type of battery.

For VRLA, float charge voltage should be between 2.2V to 2.3V, default setting is 2.25V.

4. Float Charge Temperature Compensation (optional)

A coefficient of temperature compensation can be set as required by the type of battery.

5. End of Discharge (EOD) Protection

If the battery voltage is lower than the EOD, the battery converter will shut down and the battery is isolated to avoid further battery discharge. EOD is adjustable from 1.6V to 1.75V per cell (VRLA).

5.4.2 Advanced Functions (Software Settings Performed by the Commissioning Engineer)

Battery self-test and self-service

At periodic intervals, 25% of the rated capacity of the battery will be discharged automatically, and the actual load must exceed 25% of the rated UPS (kVA) capacity. If the load is less than 25%, auto-discharge cannot be executed. The periodic interval can be set from 720 to 3000 hours.

Conditions: Battery at float charge for at least 5 hours, load equal to 25~100% of rated UPS capacity Trigger—Manually through the command of Battery Maintenance Test in LCD panel or automatically Battery self-test interval.

5.5 Battery Protection (Settings by Commissioning Engineer)

Battery Low Pre-warning

The battery undervoltage pre-warning occurs before the end of discharge. After this pre-warning, the battery should have the capacity for 3 remaining minutes discharging with full load. And the



End of discharge (EOD) protection

If the battery voltage is lower than the EOD, the battery converter will be shut down. EOD is adjustable from 1.6V to 1.75V per cell (VRLA).

Battery Disconnect Devices Alarm

The alarm occurs when the battery disconnect device disconnects. The external battery connects to the UPS through the external battery circuit breaker. The circuit breaker is manually closed and tripped by the UPS control circuit.

Chapter 6 Operating Instructions

 	Warning-Hazardous mains voltage and/or battery voltage present(s) behind the protective cover
The components that can only be accessed by opening the protective cover with tools cannot be operated by user. Only qualified service personnel are authorized to remove such covers.	

6.1 Introduction

The Modular UPS operates in the following 3 modes listed in *table.6-1*. This section describes various kinds of operating procedures under each operating mode, including transfer between operating modes, UPS setting and procedures for turning on/off inverter.

Tab.6-1: UPS Operating mode

Operating mode	Descriptions
Normal mode	UPS powers the load
Bypass mode	The load power supply is provided by the static bypass. This mode can be regarded as a temporary transition mode between the normal mode and maintenance bypass mode, or a temporary abnormal operating status
Maintenance mode	UPS Shuts down, the load is connected to the mains via Maintenance bypass. NOTE: in this mode the load is not protected against abnormal mains

Note:

1. Refer to Chapter 7 Operator Control and Display Panel, for all the user operating keys and LED displays.
2. The audible alarm may annunciate at various points in these procedures.
3. The UPS function can be set via maintenance software. However, the setting and commissioning must be done by maintenance engineers trained.

6.1.1 Power Switches

The UPS rack system has a manual bypass breaker, a bypass input breaker, and all the other transfers are processed automatically by internal control logics.

Customer must install an external mains input breaker, an external maintenance bypass breaker and an external output breaker. An external bypass breaker is needed if split-bypass is applied for.

	Note
It's recommended that 4-poles breakers are used, and the rated current is higher than rated current of bypass breaker in UPS. For 40KVA, 125A breakers are needed. For 20KVA, 63A breakers are needed.	

6.2 UPS Startup

Do not start the UPS until the installation is completed, the system has been commissioned by authorized personnel and the external power isolators are closed.

6.2.1 Start-Up Procedure

This procedure must be followed when turning on the UPS from a fully powered down condition.

The operating procedures are as follows:

1. Open the external power switch. Open the internal power switch. Open the UPS door, connect the power supply cables and ensure the correct phase rotation.

	Warning
---	----------------

During this procedure the UPS output terminals are live. If any load equipment are connected to the UPS output terminals please check with the load user that it is safe to apply power: If the load is not ready to receive power then ensure that it is safely isolated from the UPS output terminals.

2. **Close external output circuit breaker. Close external mains input circuit breaker and connect the mains power.** The LCD starts up at this time. The Rectifier indicator flashes during the startup of rectifier. The rectifier enters normal operation state, and after about 20s, the rectifier indicator goes steady green. After initialization, the bypass static switch closes. The UPS Mimic LEDs will indicate as following:

LED	Status
Rectifier indicator	Green
Battery indicator	Red
Bypass indicator	Green
Inverter Indicator	Off
Load indicator	Green
Status indicator	Red

3. **The inverter starts up automatically.** The inverter indicator flashes during the startup of inverter. After about 1minute, the inverter is ready, the UPS transfers from bypass to inverter, the bypass indicator turns off, and the inverter and load indicators turn on. The UPS is in normal mode. The UPS Mimic LEDs will indicate as following:

LED	Status
Rectifier indicator	Green
Battery indicator	Red
Bypass indicator	Off
Inverter Indicator	Green
Load indicator	Green
Status indicator	Red

4. Close external battery switch, battery indicator turns off, a few minutes later, the battery will be charged by UPS. The UPS Mimic LEDs will indicates as following:

LED	Status
Rectifier indicator	Green
Battery indicator	Green
Bypass indicator	Off
Inverter Indicator	Green
Load indicator	Green
Status indicator	Green



Note

The panel on 6-power modules cabinet has 6 mimic indicators: rectifier, inverter, bypass, battery, load, status.
The panel on 2/4-power modules cabinet has only status LED.

6.2.2 Procedures for Switching Between Operation Modes

Switch from normal mode to bypass mode



Press “ Transfer to Bypass ” menu in menu “operate” to switch to bypass mode.



Note

In bypass mode, the load is directly fed by the mains power instead of the pure AC power from the inverter.

Switch from bypass mode to normal mode



Press “ Esc Bypass ” menu in bypass mode. After the inverter enters in normal operation, the UPS transfers to normal mode.

6.3 Procedure for Switching the UPS between Maintenance Bypass and Normal Mode

6.3.1 Procedure for Switching from Normal Mode to Maintenance Bypass Mode

This procedure can transfer the load from the UPS inverter output to the maintenance bypass supply, but the precondition is that the UPS is in normal mode before the transfer.



Caution

Before making this operation, read messages on display to be sure that bypass supply is regular and the inverter is synchronous with it, so as not to risk a short interruption in powering the load.



1. Press the “**Transfer to Bypass**” menu in “operate” on the right side of the LCD.
The UPS Mimic indicator Inverter will green flash and also the Status Indicator will turn red and will be accompanied by an audible alarm. The load transfers to static bypass, and the inverter standby.



Note

Pressing the mute off button  in “operate” menu to cancel the audible alarm but leaves the warning message displayed until the alarm condition is rectified.

2. Close the manual bypass breaker from OFF to ON position. The load power supply is provided by the manual bypass.
3. Press EPO to make sure the charge current is 0. Open the external battery breaker and internal battery breaker (if built-in battery cabinet). Then power modules can be maintained.
4. If cabinet maintenance is needed, external maintenance bypass breaker is required. If external maintenance bypass breaker is available, close external maintenance bypass breaker, open the external input breaker and external output breaker, then UPS cabinet can be maintained. It's recommended that external maintenance breaker are installed as *fig.6-1*:

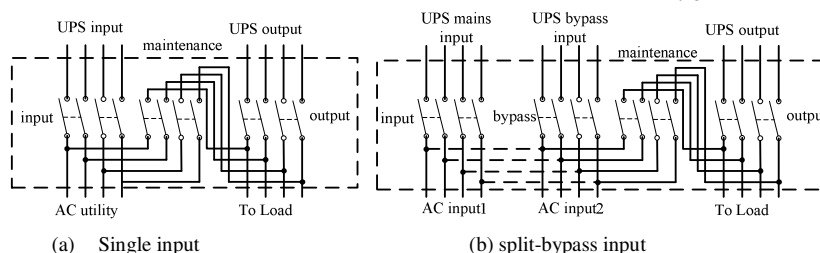

Fig.6- 1: External Maintenance Bypass



Warning

If you need to maintain the module, wait for 10 minutes to let the DC bus capacitor fully discharge before removing corresponding module.

When the manual bypass switch is on position of ON, some part of the UPS circuit still has hazardous voltage. Therefore, only qualified person can maintain the UPS.



Note

When the UPS is in maintenance bypass or manual bypass mode, the load is not protected against abnormal mains supply. There is no bypass breaker in 6 power modules cabinet.

6.3.2 Procedure for Switching from Maintenance Mode to Normal Mode

1. Close bypass breaker if available. Close manual bypass breaker. Close external output breaker. Close external mains input breaker. The LCD starts up at this time. The rectifier indicator flashes during the startup of rectifier. The rectifier enters normal operation state, and after about 20s, the rectifier indicator goes steady green. After initialization, the bypass static switch closes and bypass indicator goes steady green.

2. Open the external maintenance breaker. Open manual bypass breaker.

 Warning
--

Before opening the maintenance breaker, make sure that static bypass switch is working according power flow displayed on LCD.

3. After about 60s, UPS transfers to inverter. Close external battery breaker and internal battery breaker (for battery built-in cabinet).

6.3.3 Procedure for Switching from normal mode to manual bypass mode



1. Press the “ Transfer to Bypass ” menu on the LCD. The UPS Mimic indicator Inverter will green flash and also the Status Indicator will turn red and will be accompanied by an audible alarm. The load transfers to static bypass, and the inverter standby.
2. Close manual bypass breaker to ON position. Open bypass breaker.
3. Press EPO button to ensure the battery current is 0. Open the battery circuit breaker or disconnect battery terminals.

 Warning
--

Make sure not to open external input breaker, otherwise, UPS output will be interrupted.

6.3.4 Procedures for Switching from manual bypass mode to normal mode



1. Press “ Fault Clear ” in function menu to clear EPO alarm.
 2. Close bypass breaker and bypass indicator goes steady green.
 3. Open manual bypass breaker.
- 
4. Press the “ Exc Bypass ” menu in bypass mode, UPS transfer to inverter after about 60s.
 5. Close external battery circuit breaker or internal battery circuit breaker.

 Warning
--

Before opening the manual breaker, make sure that static bypass switch is working according power flow displayed on LCD.

6.4 Procedure for Completely Powering Down a UPS

If you need to power down the UPS completely, follow the procedures as:

- Press EPO button on the front panel
- Open external battery breaker and internal battery breaker
- Open bypass breaker, external input breaker, external output breaker

If the rectifier and bypass use different power supply, you need to open these two input breakers respectively.

6.5 EPO Procedure

The EPO button is designed to switch off the UPS in emergency conditions (e.g., fire, flood, etc.).To achieve this, just press the EPO button, and the system will turn off the rectifier, inverter and stop powering the load immediately (including the inverter and bypass), and the battery stops charging or discharging.

If the input utility is present, the UPS control circuit will remain active; however, the output will be turned off. To completely isolate the UPS, you need to open the mains input breaker and battery breaker.

6.6 Auto Start

Commonly, the UPS rack is start up on static bypass. When the mains power fails, the UPS draws power from the battery system to supply the load until the battery voltage reaches the end of discharge (EOD) voltage, and the UPS will shut down.

The UPS will automatically restart and enable output power:

- After the mains power is restored
- If the Auto Recovery after EOD Enabling feature is enabled

6.7 UPS Reset Procedure

After using EPO to shut down the UPS, operates as following to restore UPS:

- Shutdown UPS completely
- Start UPS as *section 6.2.1*

After the UPS is shut down due to inverter over temperature, or overload, or too many switching times, UPS will reset the fault automatically when fault is cleared.



Note

The rectifier will be turned on automatically when the over temperature fault disappears after the disappearance of over temperature signals.

After pressing the EPO button, if the UPS mains input has been disconnected, the UPS is completely powered down. When the mains input is restored, the EPO condition will be cleared and the UPS system will enable static bypass mode to restore the output.



Warning

If the maintenance bypass breaker is put to ON and the UPS has mains input, then the UPS output is energized.

6.8 Operation Instruction for Power Module Maintenance

Only a trained operator can perform the following procedures

Maintenance guidance for power modules

If the system is normal mode and the bypass is normal, the redundant number of power module is at least 1:

1. Enter in function menu and press “ Enable Module OFF Button” to release shutdown power module function.
2. Press “off” button on the front panel of power module to manually power off power module.
3. Remove decorative metal strip on two sides and loose the screws of the power module, then remove the module after 5 minutes.

If there are no redundant power modules:

1. Enter in function menu and press “ Transfer to Bypass” to transfer to bypass mode.
2. Remove decorative metal strip on both sides and loose the screws of the power module, then remove the module after 5 minutes.



Note

To ensure the safety, be sure to use a multi-meter to measure the DC bus capacitor voltage and ensure the voltage is below 60V before operation.

3. After finishing the maintenance of the power module, insert the main power module (the inserting interval for each module is longer than 10s), the power module will automatically join the system operation, and then tighten the screws at two sides of the power module.
4. Fix the decorative metal strip to cover screws on both sides of front panel.

Maintenance guidance for bypass power module



Note

The bypass power module cannot be maintained in battery mode.

If the system is in normal mode and the bypass is normal:

1. Manually shut down the inverter, and the UPS transfers to bypass. Close the manual bypass breaker and the UPS transfer to manual bypass. Open the bypass breaker to shutdown bypass.
2. Press EPO button to ensure the battery current is 0. Open the battery circuit breaker or disconnect battery terminals.
3. Remove the bypass power modules that need maintenance or repair, wait for 5 minutes and then maintain the bypass power modules. After finishing the maintenance of the bypass power modules, insert the modules.
4. Transfer to normal mode as *section 6.3.2*.



Note

The terminal of bypass power module is big, and it need more power when inserting bypass module to make sure tighten connection.

6.9 Language Selection

The LCD menus and data display are available in 7 languages: Simple Chinese, English, Traditional Chinese, Turkish, Russian, Polish, Portuguese.

Perform the following procedure to select a language needed:



1. In main menu, press “” to enter in setting menu on the LCD screen.
2. Select LANGUAGE menu.
3. Select the language. At this time, all the words in the LCD will be displayed in the selected language.

6.10 Changing the Current Date and Time

To change system date and time:



1. In main menu, press “” to enter in function setting menu in the LCD screen.
2. Select DATE&TIME.
3. Enter new date and time, then enter to confirm it.

6.11 Control Password 1

The system is password protected to limit the operator’s operating and control authorities. You can only operate and test the UPS and battery after entering correct password 1. The default password 1 is **1203**.

Chapter 7 Operator Control and Display Panel

This chapter introduces the functions and operation instructions of the UPS operator control and display panel in detail, and provides LCD display information, including LCD display types, detailed menu information, prompt window information and UPS alarm list.

7.1 Introduction

The operator control and display panel is located on the front panel of the UPS. Through the LCD panel, the operator can operate and control the UPS, and check all measured parameters, UPS and battery status, event and history logs. The operator control panel is divided into three functional areas as shown in *fig.7-1*: mimic current path, LCD display & Menu, control and operation button. The detailed description of control and display panel is shown in *table.7-1*.



(a) 3-modules and 6-modules cabinet

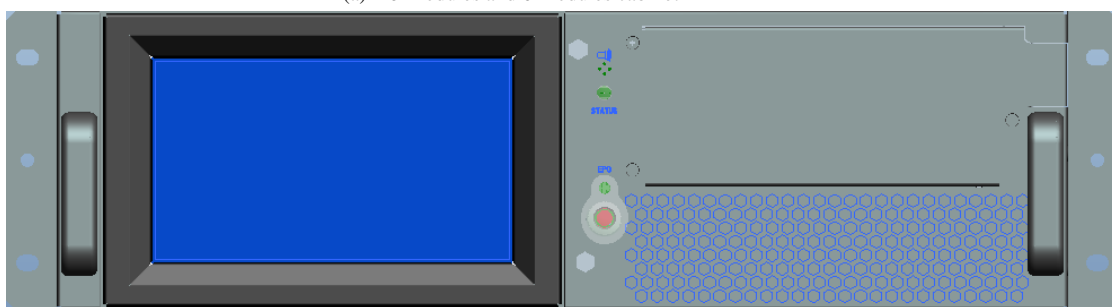

(b) 2-modules and 4-modules cabinet

Fig.7- 1: UPS operator control and display panel

Table.7- 1: Description of UPS Operator Control and Display Panel

Indicator	Function	Button	Function
REC	Rectifier indicator(90kVA)	EPO	EPO (emergency power off)
BAT	Battery indicator(90kVA)	HOME	Back to main menu(90kVA)
BYP	Bypass indicator(90kVA)	Left arrow	Select main menu items; switch between submenu; increase or reduce for number input(90kVA)
INV	Inverter indicator(90kVA)	Right arrow	
OUTPUT	Load indicator(90kVA)	ENTER	Confirm(90kVA)
STATUS	Status indicator		

7.1.1 Mimic Current Path

The LEDs shown on the mimic current path represent the various UPS power paths and show the current UPS operating status. The status description of indicators is shown in *table.7-2*.

Table.7- 2: Status Description of Indicator

Indicator	State	Description
Rectifier indicator	Steady green	Rectifier of all modules is normal
	Flashing green	At least one of module rectifier is starting
	Steady red	At least one Rectifier of module fault
	Flashing red	Main input of at least one module is abnormal
	Off	Rectifier is not working
Battery indicator	Steady green	Battery is charging
	Flashing green	Battery is discharging
	Steady red	Battery is abnormal (battery failure, no battery or battery reverse) or battery converter is abnormal (failure, over current or over temperature) , EOD
	Flashing red	Battery voltage is low
	Off	Battery and battery converter is normal, battery is not charging
Bypass indicator	Steady green	UPS is working in bypass mode
	Steady red	Bypass is failure
	Flashing red	Bypass voltage is abnormal
	Off	Bypass is normal and is not working
Inverter indicator	Steady green	Inverter is feeding the load
	Flashing green	Inverter is starting, or UPS is working in ECO mode
	Steady red	At least one module's inverter is failure, and inverter is not feeding the load
	Flashing red	Inverter is feeding load, and at least one module's inverter is failure
	Off	Inverter is not working in all modules
Load indicator	Steady green	UPS output is on and is normal
	Steady red	UPS output is overload and time is over, or output is shorten, or output has no power supply
	Flashing red	UPS is overload
	Off	No output voltage
Status indicator	Steady green	Normal operation
	Steady red	Fault

7.1.2 Audible Alarm (buzzer)

There are two different types of audible alarm during UPS operation as shown in *table.7-3*.

Table.7- 3: Description of Audible Alarm

Alarm	Purpose
Two short, one long	when system has general alarm (for example: main input abnormal), this audible alarm can be heard
Continuous alarm	When system has serious faults (for example: fuse or hardware fault), this audible alarm can be heard

7.1.3 Functional Keys

There are 4 functional buttons on operator control and display panel, which are used together with LCD. The functions description is shown in *table.7-4*.

Table.7- 4: Functions of Functional Keys

Functional key	Functions
EPO	To cut off the load power to shut down the rectifier, inverter, static bypass and battery
HOME	To return the main menu
Left arrow and right arrow	Select options in the main menu, switch over secondary menu pages, upward and downward roll the historical log, add and subtract the entered number
Enter	confirm

7.1.4 Battery Pack Indicator

The LED on the front panel of battery pack indicates battery pack status. If battery fuse in battery pack is broken, LED changes to be red. Customer must contact with our local distributor to maintain it.

7.2 LCD Display Type

Following the self-check of UPS LCD display, the main LCD display is shown as *fig.7-2*, which can be divided into 4 display windows: system information, power path, current record and main menu.

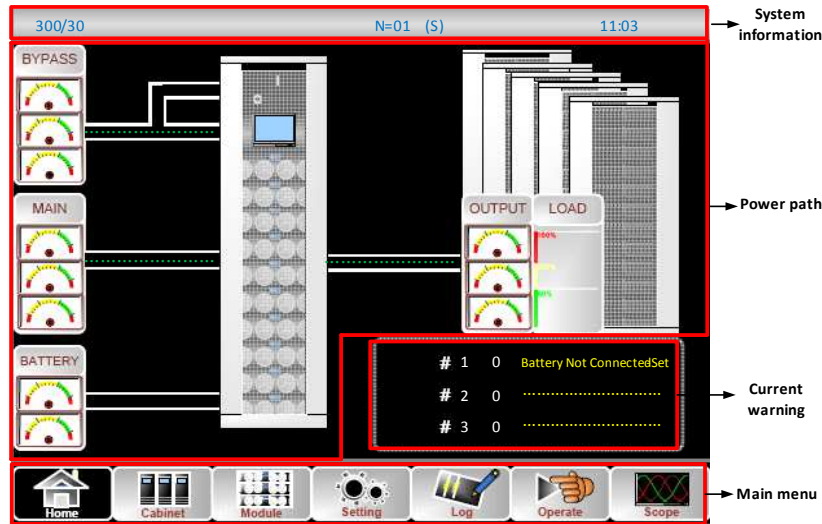

Fig.7- 2: Main LCD Display

The description of LCD icon is shown in *table.7-5*:

Table.7- 5: Description of LCD Icons

Icon	Description
	Return to main menu page
	Bypass, main, output (voltage, current, PF, frequency), battery information(capacity, remained time, worked days, battery temperature, ambient temperature), load information(percent, active load, reactive load, apparent load)
	Information of power module(main, output, load, S-code, module information)
	DATE&TIME, LANGUAGE, COMMUNICATION, USER(use user password 1), BATTERY set, SERVICE set, RATE set, CONFIGURE
	History LOG
	Mute ON/OFF, Fault clear, transfer to bypass, transfer to inverter, enable module "off", reset battery history data, reset dust filter using time, battery test, battery maintenance, battery boost, battery float, stop test
	Scope of output voltage, output current, bypass voltage

The LCD menu tree is shown as below. Please refer to *table. 7-7*: Item Description of UPS Menu

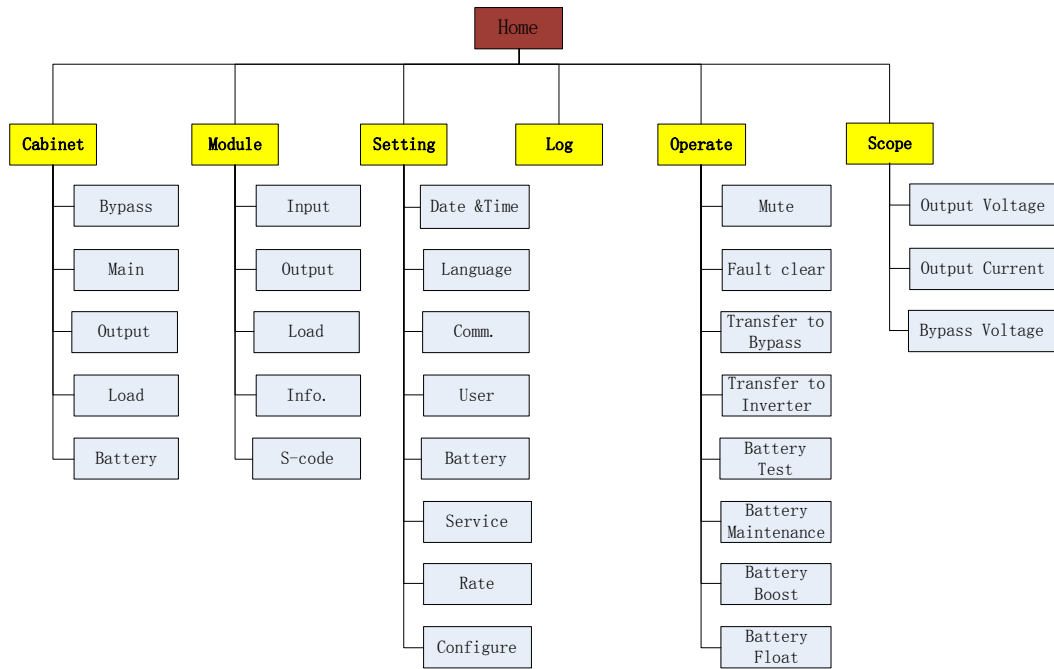

Fig.7- 3: Menu Structure

7.3 Detailed Description of Menu Items

The LCD main display shown in fig.7-2 is described in details below.

UPS system information window

UPS information window: unit model, module numbers, unit mode, current date and time are displayed. The information of the window is not necessary for the user to operate. The information of this window is given in table.7-6.

Table.7- 6: Description of Items in UPS System Information Window

Display contents	Meaning
300/30	Unit model: 300—unit capacity, 30—power modules capacity
N=01	1 Power module in system
(s)	Unit mode: S--single unit, P-0/1--parallel mode, E--ECO mode, L--LBS mode, PE-0/1--parallel ECO mode, PL-0/1--parallel LBS mode
11:03	Date and time

Main menu window

Details of UPS menu is shown in Table.7-5.

Enter in  to get cabinet information.

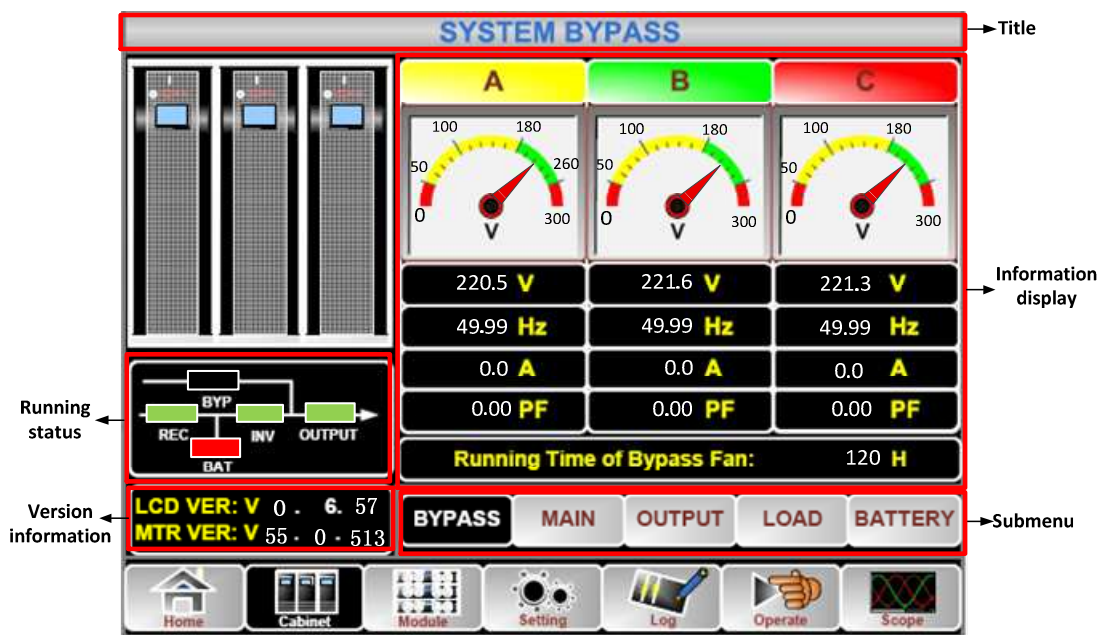
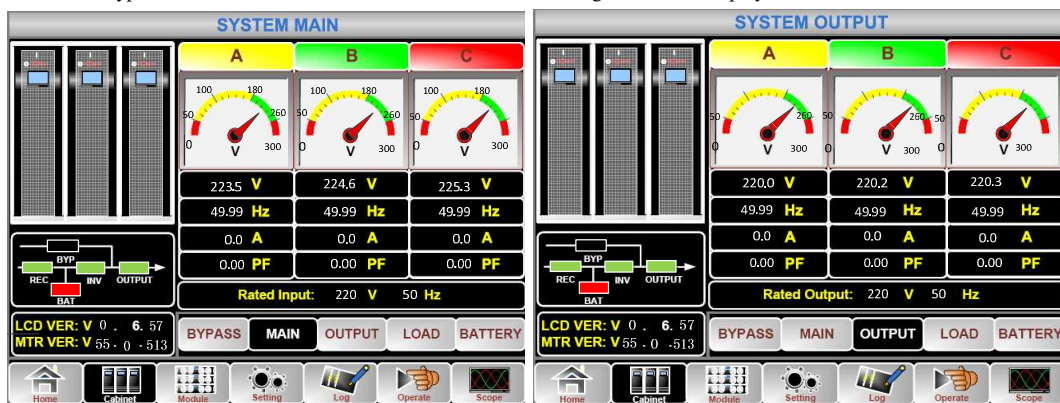

Fig.7- 4: cabinet menu

Submenu BYPASS, MAIN, OUTPUT

Bypass information, main input and output information (voltage, current, frequency, PF) are displayed in cabinet menu, voltage is also shown in meter type. Current mimic status indicators, LCD and monitoring version are displayed. Shown as below:



(a) Main input information (b) output information

Fig.7- 5: main input and output information

Submenu LOAD, BATTERY

Load information includes load percent, active load, reactive load, apparent load. Battery information includes battery number, battery voltage, battery current, remained capacity, remained discharge time, discharge times, working days, discharge hours, battery temperature (optional), ambient temperature (optional). Shown as below:

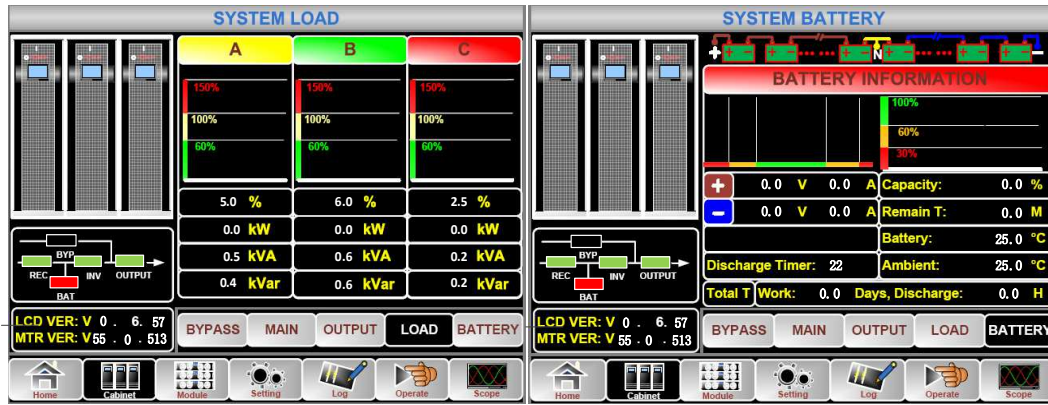

(a) system load information (b) system battery information

Fig.7- 6: load and battery information

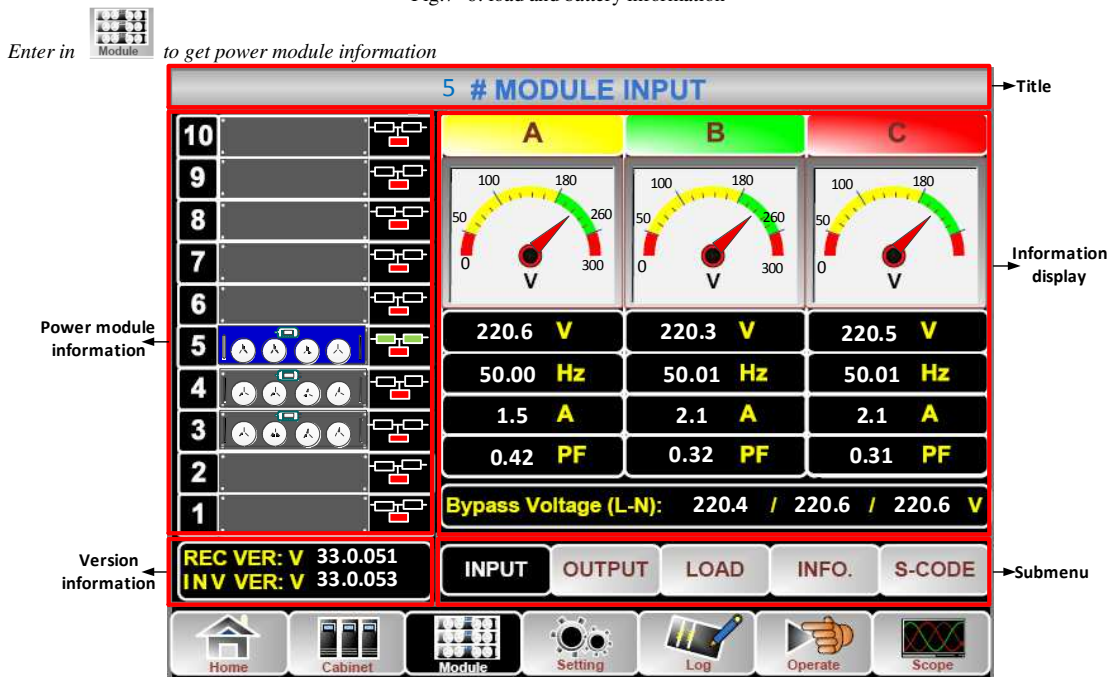
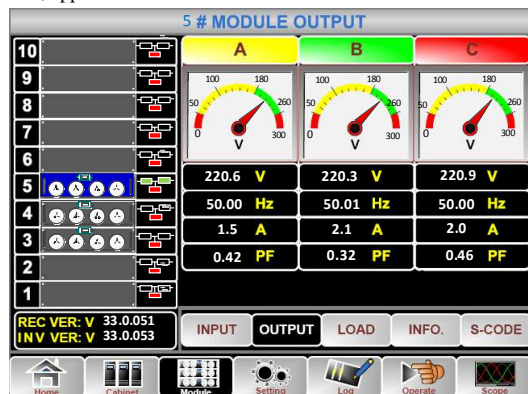

Fig.7- 7: power module information

Module information menu includes: input, output, load, internal information, S-code, software version.

Submenu INPUT, OUTPUT, LOAD

Input and output information include voltage, current, frequency, PF. Load information includes load percent, active load, reactive load, apparent load. Shown as below:



(a) module output information (b) module load information
Fig.7- 8: module output and load information

Submenu INFO., S-Code

INFO menu includes modules battery information, inlet temperature, outlet temperature, IGBT temperature. And S-code menu displays S-code of power module to indicate what has happened to power module.



(a) module information (b) S-code of the power module
Fig.7- 9: module information and S-code

Enter in  to set UPS system.

It includes DATE&TIME, LANGUAGE, COMM., USER, BATTERY, SERVICE, RATE, CONFIGURE. And submenu BATTERY, SERVICE, RATE, CONFIGURE is only available for service engineer or manufacturer.

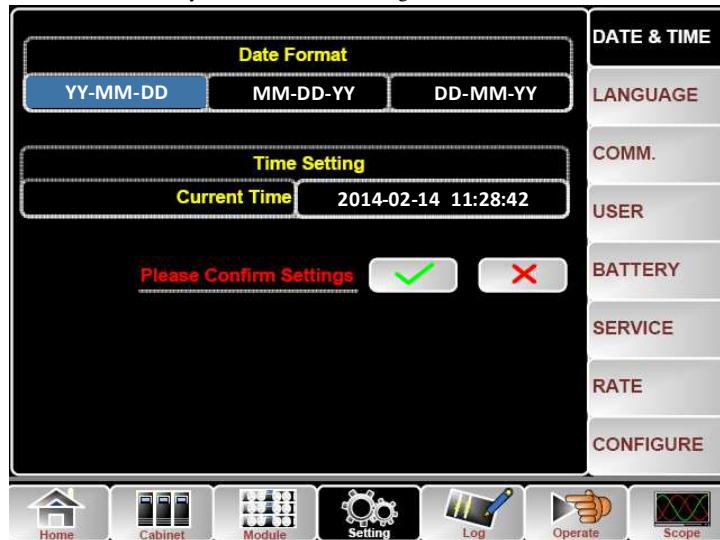



Fig.7- 10: Setting Menu

Table.7- 7: description of details of submenu in setting

Submenu Name	Contents	Meaning
Date&Time	Date format setting	Three format: (a) year/month/day,(b) moth/date/year, (c) date/month/year
	Time setting	Setting time
Language	Current language	Language in use
	Language selection	Simplified Chinese and English selectable (The setting taking action immediately after touching the language icon)
COMM.	Device Address	Setting the communication address

Submenu Name	Contents	Meaning
	RS232 Protocol Selection	SNT Protocol, ModBus Protocol, YD/T Protocol and Dwin (For factory use)
	Baudrate	Setting the baudrate of SNT, ModBus and YD/T
	Modbus Mode	Setting mode for Modbus:ASCII and RTU selectable
	Modbus parity	Setting the parity for Modbus
USER	Output voltage Adjustment	Setting the Output Voltage
	Bypass Voltage Up Limited	Up limited working Voltage for Bypass, settable:+10%, +15%, +20%, +25%
	Bypass Voltage Down Limited	Down limited working Voltage for Bypass, settable:-10%, -15%, -20%, -30%, -40%
	Bypass Frequency Limited	Permitted working Frequency for Bypass Settable: +-1Hz, +-3Hz, +-5Hz
	Dust Filter Maintenance Period	Setting Dust Filter Maintenance Period
BATTERY	Battery Number	Setting the number of the battery (12V)
	Battery Capacity	Setting of the AH of the battery
	Float Charge Voltage/Cell	Setting the floating Voltage for battery cell (2V)
	Boost Charge Voltage/Cell	Setting the boost Voltage for battery cell (2V)
	EOD(End of charge) Voltage/Cell,@0.6C Current	EOD voltage for cell battery,@0.6C
	EOD(End of charge) Voltage/Cell,@0.15C Current	EOD voltage for cell battery,@0.15C
	Charge Current Percent Limit	Charge current (percentage of the rated current)
	Battery Temperature Compensate	Coefficient for battery temperature compensation
	Boost Charge Time Limit	Setting boost charging time
	Auto Boost Period	Setting the auto boost period
	Auto Maintenance Discharge Period	Setting the period for auto maintenance discharge
SERVICE	System Mode	Setting the system mode: Single ,parallel, Single ECO, parallel ECO,LBS, parallel LBS
RATE	Configure the rated Parameter	For the factory use
CONFIGURE	Configure the system	For the factory use

Enter in  to get history log of UPS system. Use   to scroll the list.

Enter in  to control UPS system. The function and test command are shown as below:

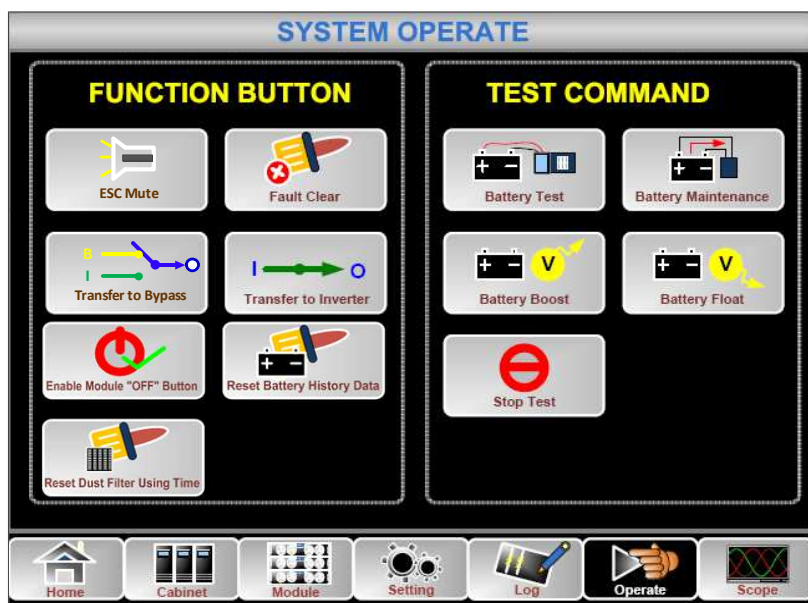

Fig.7- 11: System Operate

Menu of Operate includes:

Functional operation



Mute off or mute on.



Fault clear manually

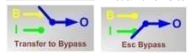

Manually transfer to bypass or escape from bypass mode



Transfer to inverter mode manually. The output could be interrupted.



Enable the "OFF" button on the front panel of power module. Then the "OFF" button is available, user can press the button to shutdown the power module.



Reset battery history data including discharge dates and hours, discharge times. Normally reset battery history data after replacing new batteries.



Reset dust filter data including days and maintenance period. Normally reset filter data after replacing new filter or washing.

Command



Battery test command. UPS transfer to battery mode, main LED indicator is dark and battery LED indicator green flashes.

If battery is sick or battery is failure, UPS will alarm and transfer back to normal mode or transfer to bypass mode. Make sure there is not any warns or alarm, make sure that battery voltage is higher than 90% of float voltage. If battery is normal, UPS will transfer back to normal mode after 20 seconds. If battery test is failure, UPS alarms in the history log.



Battery maintenance command. UPS transfer to battery mode, main LED indicator is dark and battery LED indicator green flashes. Make sure that there is not any warns or alarm, make sure that battery voltage is higher than 90% of float voltage. If battery is normal, UPS will transfer back to normal mode until battery voltage is down to 105% of EOD voltage and then transfer back to normal mode.



Manually enable charger enter in boost charge mode to charge the batteries more quickly.



Manually enable charger enter in float charge mode.



Stop battery test or battery maintenance.



Enter in main menu  to see the waveform of output voltage, current and bypass voltage.

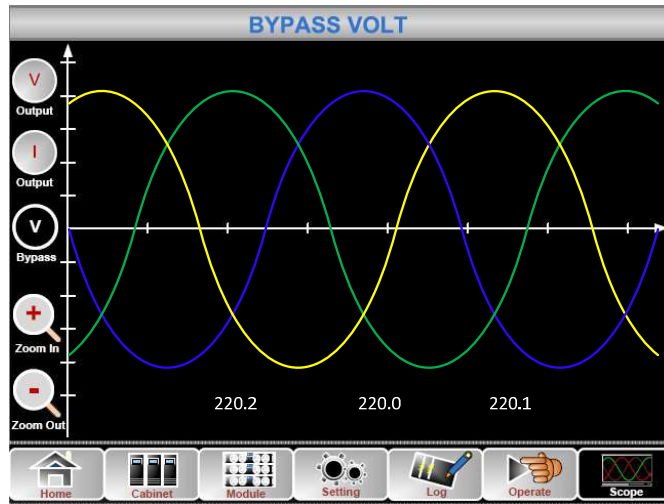

Fig.7- 12: output and bypass waveform

7.4 UPS Event Log

The follow *table.7-8* gives the complete list of all the UPS events displayed by history record window and current record window.

Table.7- 8: UPS Event List

NO.	UPS events	Description
1	Fault Clear	Manually clear fault
2	Log Clear	Manually clear History log
3	Load On UPS	Inverter feeds load
4	Load On Bypass	Bypass feeds load
5	No Load	No load
6	Battery Boost	Charger is working in boost charging mode
7	Battery Float	Charger is working in float charging mode
8	Battery Discharge	Battery is discharging
9	Battery Connected	Battery is connected already
10	Battery Not Connected	Battery is not yet connected.
11	Maintenance CB Closed	Manual maintenance breaker is closed
12	Maintenance CB Open	Manual maintenance breaker is opened
13	EPO	Emergency Power Off
14	Module On Less	Available power module capacity is less then the load capacity. Please reduce the load capacity or add extra power module to make sure that the UPS capacity is big enough.
15	Generator Input	Generator is connected and a signal is sent to the UPS.
16	Utility Abnormal	Utility (Grid) is abnormal. Mains voltage or frequency exceeds the upper or lower limit and results in rectifier shutdown. Check the input phase voltage of rectifier.
17	Bypass Sequence Error	Bypass voltage Sequence is reverse. Check if input power cables are connected correctly.
18	Bypass Volt Abnormal	This alarm is triggered by an inverter software routine when the amplitude or frequency of bypass voltage exceeds the limit. The alarm will automatically reset if the bypass voltage becomes normal. First check if relevant alarm exists, such as “bypass circuit breaker open”, “By Sequence Err” and “Ip Neutral Lost”. If there is any relevant alarm, first clear this alarm. 1. Then check and confirm if the bypass voltage and frequency displayed on the LCD are within the setting range. Note that the rated voltage and frequency are respectively specified by “Output Voltage” and “Output Frequency”.

		2. If the displayed voltage is abnormal, measure the actual bypass voltage and frequency. If the measurement is abnormal, check the external bypass power supply. If the alarm occurs frequently, use the configuration software to increase the bypass high limit set point according to the user's suggestions
19	Bypass Module Fail	Bypass Module Fails. This fault is locked until power off. Or bypass fans fail.
20	Bypass Module Over Load	Bypass current is over the limitation. If bypass current is under 135% of the rated current. The UPS alarms but has no action.
21	Bypass Over Load Tout	The bypass overload status continues and the overload times out.
22	Byp Freq Over Track	This alarm is triggered by an inverter software routine when the frequency of bypass voltage exceeds the limit. The alarm will automatically reset if the bypass voltage becomes normal. First check if relevant alarm exists, such as "bypass circuit breaker open", "Byp Sequence Err" and "Ip Neutral Lost". If there is any relevant alarm, first clear this alarm. 1. Then check and confirm if the bypass frequency displayed on the LCD are within the setting range. Note that the rated frequency are respectively specified by "Output Frequency". 2. If the displayed voltage is abnormal, measure the actual bypass frequency. If the measurement is abnormal, check the external bypass power supply. If the alarm occurs frequently, use the configuration software to increase the bypass high limit set point according to the user's suggestions
23	Exceed Tx Times Lmt	The load is on bypass because the output overload transfer and re-transfer is fixed to the set times during the current hour. The system can recover automatically and will transfer back to the inverter with 1 hour
24	Output Short Circuit	Output shorted Circuit. Fist check and confirm if loads have something wrong. Then check and confirm if there is something wrong with terminals, sockets or some other power distribution unit. If the fault is solved, press "Fault Clear" to restart UPS.
25	Battery EOD	Inverter turned off due to low battery voltage. Check the mains power failure status and recover the mains power in time
26	Battery Test	System transfer to battery mode for 20 seconds to check if batteries are normal
27	Battery Test OK	Battery Test OK
28	Battery Maintenance	System transfer to battery mode until to be 1.1*EOD voltage to maintenance battery string
29	Battery Maintenance OK	Battery maintenance succeed
30	Module inserted	Power Module is inserted in system.
31	Module Exit	Power Module is pulled out from system.
32	Rectifier Fail	The N# Power Module Rectifier Fail, The rectifier is fault and results in rectifier shutdown and battery discharging.
33	Inverter Fail	The N# Power Module Inverter Fail. The inverter output voltage is abnormal and the load transfers to bypass.
34	Rectifier Over Temp.	The N# Power Module Rectifier Over Temperature. The temperature of the rectifier IGBTs is too high to keep rectifier running. This alarm is triggered by the signal from the temperature monitoring device mounted in the rectifier IGBTs. The UPS recovers automatically after the over temperature signal disappears. If over temperature exists, check: 1. Whether the ambient temperature is too high. 2. Whether the ventilation channel is blocked. 3. Whether fan fault happens. 4. Whether the input voltage is too low.
35	Fan Fail	At least one fan fails in the N# power module.
36	Output Over load	The N# Power Module Output Over Load. This alarm appears when the load rises above 100% of nominal rating. The alarm automatically resets once the overload condition is

		<p>removed.</p> <ol style="list-style-type: none"> 1. Check which phase has overload through the load (%) displayed in LCD so as to confirm if this alarm is true. 2. If this alarm is true, measure the actual output current to confirm if the displayed value is correct. <p>Disconnect non-critical load. In parallel system, this alarm will be triggered if the load is severely imbalanced.</p>
37	Inverter Overload Tout	<p>N# Power Module Inverter Over Load Timeout. The UPS overload status continues and the overload times out.</p> <p>Note: The highest loaded phase will indicate overload timing-out first. When the timer is active, then the alarm “unit over load” should also be active as the load is above nominal. When the time has expired, the inverter Switch is opened and the load transferred to bypass. If the load decreases to lower than 95%, after 2 minutes, the system will transfer back to inverter mode. Check the load (%) displayed in LCD so as to confirm if this alarm is true. If LCD displays that overload happens, then check the actual load and confirm if the UPS has over load before alarm happens.</p>
38	Inverter Over Temp.	<p>The N# Power Module Inverter Over Temperature.</p> <p>The temperature of the inverter heat sink is too high to keep inverter running. This alarm is triggered by the signal from the temperature monitoring device mounted in the inverter IGBTs. The UPS recovers automatically after the over temperature signal disappears.</p> <p>If over temperature exists, check: Whether the ambient temperature is too high. Whether the ventilation channel is blocked. Whether fan fault happens. Whether inverter overload time is out.</p>
39	On UPS Inhibited	<p>Inhibit system transfer from bypass to UPS (inverter). Check: Whether the power module’s capacity is big enough for load. Whether the rectifier is ready. Whether the bypass voltage is normal.</p>
40	Manual Transfer Byp	Transfer to bypass manually
41	Esc Manual Bypass	Escape from “transfer to bypass manually” command. If UPS has been transferred to bypass manually, this command enable UPS to transfer to inverter.
42	Battery Volt Low	Battery Voltage is Low. Before the end of discharging, battery voltage is low warning should occur. After this pre-warning, battery should have the capacity for 3 minutes discharging with full load.
43	Battery Reverse	Battery cables are connected not correctly.
44	Inverter Protect	<p>The N# Power Module Inverter Protect. Check: Whether inverter voltage is abnormal Whether inverter voltage is much different from other modules, if yes, please adjust inverter voltage of the power module separately.</p>
45	Input Neutral Lost	The mains neutral wire is lost or not detected. For 3 phases UPS, it’s recommended that user use a 3-poles breaker or switch between input power and UPS.
46	Bypass Fan Fail	At least one of bypass module Fans Fails
47	Manual Shutdown	The N# Power Module is manually shutdown. The power module shuts down rectifier and inverter, and there’s on inverter output.
48	Manual Boost Charge	Manually force the Charger work in boost charge mode.
49	Manual Float Charge	Manually force the charger work in float charge mode.
50	UPS Locked	Forbidden to shutdown UPS power module manually.
51	Parallel Cable Error	<p>Parallel cables error. Check: If one or more parallel cables are disconnected or not connected correctly If parallel cable round is disconnected</p>

		If parallel cable is OK
52	Lost N+X Redundant	Lost N+X Redundant. There is no X redundant powers module in system.
53	EOD Sys Inhibited	System is inhibited to supply after the battery is EOD (end of discharging)
54	Battery Test Fail	Battery Test Fail. Check if UPS is normal and battery voltage is over 90% of float voltage.
55	Battery Maintenance Fail	Check If UPS is normal and not any alarms If the battery voltage is over 90% of float voltage If load is over 25%
56	Ambient Over Temp	Ambient temperature is over the limit of UPS. Air conditioners are required to regulate ambient temperature.
57	REC CAN Fail	Rectifier CAN bus communication is abnormal. Please check if communication cables are not connected correctly.
58	INV IO CAN Fail	IO signal communication of inverter CAN bus is abnormal. Please check if communication cables are not connected correctly.
59	INV DATA CAN Fail	DATA communication of inverter CAN bus is abnormal. Please check if communication cables are not connected correctly.
60	Power Share Fail	The difference of two or more power modules' output current in system is over limitation. Please adjust output voltage of power modules and restart UPS.
61	Sync Pulse Fail	Synchronization signal between modules is abnormal. Please check if communication cables are not connected correctly.
62	Input Volt Detect Fail	Input voltage of N# power module is abnormal. Please check if the input cables are connected correctly. Please check if input fuses are broken. Please check if utility is normal.
63	Battery Volt Detect Fail	Battery voltage is abnormal. Please check if batteries are normal. Please check if battery fuses are broken on input power board.
64	Output Volt Fail	Output voltage is abnormal.
65	Bypass Volt Detect Fail	Bypass voltage is abnormal. Please check if bypass breaker is closed and is good. Please check if bypass cables are connected correctly.
66	INV Bridge Fail	Inverter IGBTs are broken and opened.
67	Outlet Temp Error	Outlet temperature of power module is over the limitation. Please check if fans are abnormal. Please check if PFC or inverter inductors are abnormal. Please check if air passage is blocked. Please check if ambient temperature is too high.
68	Input Curr Unbalance	The difference of input current between every two phases is over 40% of rated current. Please check if rectifier's fuses, diode, IGBT or PFC diodes are broken. Please check if input voltage is abnormal.
69	DC Bus Over Volt	Voltage of DC bus capacitors is over limitation. UPS shutdown rectifier and inverter.
70	REC Soft Start Fail	While soft start procedures are finished, DC bus voltage is lower than the limitation of calculation according utility voltage. Please check 1. Whether rectifier diodes are broken 2. Whether PFC IGBTs are broken 3. Whether PFC diodes are broken 4. Whether drivers of SCR or IGBT are abnormal 5. Whether soft start resistors or relay are abnormal
71	Relay Connect Fail	Inverter relays are opened and cannot work or fuses are broken.
72	Relay Short Circuit	Inverter relays are shorted and cannot be released.
73	PWM Sync Fail	PWM synchronizing signal is abnormal

74	Intelligent Sleep	UPS works in intelligent sleep mode. In this mode, the power modules will be standby in turn. It will be more reliability and higher efficiency. It must be confirmed that remained power modules' capacity is big enough to feed load. It must be conformed that working modules' capacity is big enough if user add more load to UPS. It's recommended that sleeping power modules are waken up if the capacity of new added loads is not sure.
75	Manual Transfer to INV	Manually transfer UPS to inverter. It's used to transfer UPS to inverter when bypass is over track. The interrupt time could be over 20ms.
76	Input Over Curr Tout	Input over current timeout and UPS transfer to battery mode. Please check if input voltage is too low and output load is big. Please regulate input voltage to be higher if it's possible or disconnect some loads.
77	No Inlet Temp. Sensor	Inlet temperature sensor is not connected correctly.
78	No Outlet Temp. Sensor	Outlet temperature sensor is not connected correctly.
79	Inlet Over Temp.	Inlet air is over temperature. Make sure that the operation temperature of UPS is between 0-40°C.
80	Capacitor Time Reset	Reset timing of DC bus capacitors.
81	Fan Time Reset	Reset timing of fans.
82	Battery History Reset	Reset battery history data.
83	Byp Fan Time Reset	Reset timing of bypass fans.
84	Battery Over Temp.	Battery is over temperature. It's optional.
85	Bypass Fan Expired	Working life of bypass fans is expired, and it's recommended that the fans are replaced with new fans. It must be activated via software.
86	Capacitor Expired	Working life of capacitors is expired, and it's recommended that the capacitors are replaced with new capacitors. It must be activated via software.
87	Fan Expired	Working life of power modules' fans is expired, and it's recommended that the fans are replaced with new fans. It must be activated via software.
88	INV IGBT Driver Block	Inverter IGBTs are shutdown. Please check if power modules are inserted in cabinet correctly. Please check if fuses between rectifier and inverter are broken.
89	Battery Expired	Working life of batteries is expired, and it's recommended that the batteries are replaced with new batteries. It must be activated via software.
90	Bypass CAN Fail	The CAN bus between bypass module and cabinet is abnormal.
91	Dust Filter Expired	Dust filter need to be clear or replaced with a new one
92	Battery Test Fail	Battery test function is forbidden. Please check if battery voltage is higher than Please check if load is higher than 25% Please check if battery connection is OK
93	Stop Test	Manually stop battery test or battery maintenance, UPS transfer back to normal mode.
94	Wave Trigger	Waveform has been saved while UPS fail
95	Bypass CAN Fail	Bypass and cabinet communicate with each other via CAN bus. Check If connector or signal cable is abnormal. If monitoring board is abnormal.
96	Firmware Error	Manufacturer used only.
97	System Setting Error	Manufacturer used only.
98	Bypass Over Temp.	Bypass module is over temperature. Please check If bypass load is overload If ambient temperature is over 40°C If bypass SCRs are assembled correctly If bypass fans are normal
99	Module ID Duplicate	At least two modules are set as same ID on the power connector board, please set the ID as correct sequence

Chapter 8 Optional Parts

8.1 Install SNMP card

SNMP card is installed on the front panel of bypass module. To install SNMP card:

1. Remove the cover of intelligent slot (*see Fig. 8-1*).
2. Install SNMP card in the slot and tighten it with screws.

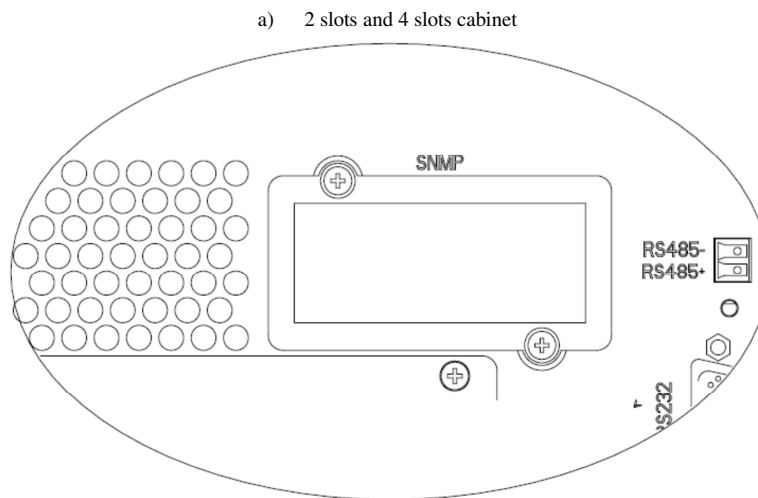

b) 3/6 slots cabinet

Fig.8- 1: SNMP card

Chapter 9 Product Specification

This chapter provides UPS product specification.

9.1 Applicable Standards

The UPS has been designed to conform to the following European and international standards:

Table.9- 1: Compliance with European and International Standards

Item	Normative reference
General safety requirements for UPS used in operator access areas	EN50091-1-1/IEC62040-1-1/AS 62040-1-1
Electromagnetic compatibility (EMC) requirements for UPS	EN50091-2/IEC62040-2/AS 62040-2(C3)
Method of specifying the performance and test requirements of UPS	EN50091-3/IEC62040-3/AS 62040-3(VFI SS 111)
Note: <i>The above mentioned product standards incorporate relevant compliance clauses with generic IEC and EN standards for safety (IEC/EN/AS60950), electromagnetic emission and immunity (IEC/EN/ AS61000 series) and construction (IEC/EN/AS60146 series and 60950).</i>	

9.2 Environmental Characteristics

Table.9- 2: Environmental Properties

Items	Unit	Requirements
Acoustic noise level at 1 meter	dB	56.0(power module)
Altitude of Operation	m	≤1000m above sea level, derate power by 1% per 100m between 1000m and 2000m
Relative Humidity	%RH	0 to 95%, non condensing
Operating Temperature	°C	0 to 40 deg , Battery life is halved for every 10°C increase above 20°C
UPS Storage-Transport Temperature	°C	-20~70
Recommended Battery Storage Temperature	°C	0~25 (20°C for optimum battery storage)

9.3 Mechanical Characteristics

Table.9- 3: Mechanical Properties

Cabinet Specification	Unit	20/10	30/15	40/10	45/15	60/10	90/15
Mechanical Dimension, W×D×H	mm	446×697×398(7U)		446×697×575(11U)		485*751*1033	
Weight	kg	42		51	55	70	
Color	N/A	Black					
Protection Level, IEC(60529)	N/A	IP20					
Module type	Unit	10/15					
Mechanical Dimension, W×D×H	mm	436×590×85					
Weight	kg	15.3/15.5					
Color	N/A	Black(front)					

9.4 Electrical Characteristics (Input Rectifier)

Table.9- 4: Rectifier AC Input (mains)

Items	Unit	Parameter
-------	------	-----------

Rated AC Input Voltage	Vac	380/400/415(three-phase and sharing neutral with the bypass input)
Input voltage range	Vac	-40%~+25%
Frequency ¹	Hz	50/60(range: 40Hz~70Hz)
Power factor	kW/kVA, full load	0.99
THD	THDI%	4

9.5 Electrical Characteristics (Intermediate DC Link)

Table.9- 5: Battery Information

Items	Unit	Parameters
Battery bus voltage	Vdc	Nominal: $\pm 240V$, one-side range: 198V~288V
Quantity of lead-acid cells	Nominal	480V=40*6cell(12V)
Float charge voltage	V/cell (VRLA)	2.25V/cell(selectable from 2.2V/cell~2.35V/cell) Constant current and constant voltage charge mode
Temperature compensation	mV/°C /cl	-3.0(selectable from : 0~-5.0, 25°C or 30°C, or inhibit)
Ripple voltage	%V float	≤ 1
Ripple current	%C10	≤ 5
Boost charge voltage	V/cell (VRLA)	2.4V/cell(selectable from : 2.30V/cell~2.45V/cell) Constant current and constant voltage charge mode
End of discharging voltage	V/cell (VRLA)	1.65V/cell(selectable from : 1.60V/cell~1.750V/cell) @0.6C discharge current 1.75V/cell (selectable from : 1.65V/cell~1.8V/cell) @0.15C discharge current (EOD voltage changes linearly within the set range according to discharge current)
Battery Charging Power	kW	10%* UPS capacity (selectable from : 1~20%* UPS capacity)

9.6 Electrical Characteristics (Inverter Output)

Table.9- 6: Inverter Output (to Critical Load)

Rated capacity (kVA)	Unit	10~90
Rated AC voltage ¹	Vac	380/400/415(three-phase four-wire and sharing neutral with the bypass)
Frequency ²	Hz	50/60
overload	%	110% load, 1 hour 125% load, 10min 150% load, 1min >150% load, 200ms
Fault current	%	300% short current limitation for 200ms
Non linear load Capability ³	%	100%
Neutral current capability	%	170%
Steady state voltage stability	%	± 1 (balanced load) ± 1.5 (100% unbalance load)
Transient voltage response ⁴	%	± 5
THD	%	< 1 (linear load) , < 5.5 (non linear load ³)
Synchronization Window	-	Rated frequency $\pm 2Hz$ (selectable: $\pm 1 \sim \pm 5Hz$)
Max change rate of synch frequency	Hz/s	1: selectable: 0.1~5
Inverter voltage range	%V(ac)	± 5
Note:		

Rated capacity (kVA)	Unit	10~90
<ol style="list-style-type: none"> 1. Factory setting is 380V. Commissioning engineers can set to 400V or 415V. 2. Factory setting is 50Hz. Commissioning engineers can set to 60Hz. 3. EN50091-3(1.4.58) crest ratio is 3: 1. 4. IEC62040-3/EN50091-3 including 0%~100%~0% load transient, the recovery time is half circle to within 5% of stable output voltage. 		

9.7 Electrical Characteristics (Bypass Input)

Table.9- 7: Bypass Input

Rated capacity(kVA)	Unit	20	40	60	30/45/90
Rated AC Voltage	Vac	380/400/415			
		three-phase four-wire, sharing neutral with the rectifier input and providing neutral reference for the output			
Rated current	A	30@ 380V	60.6@380V	90@380V	45/68/135@380V
		29@400V	58@400V	87@400V	43/65/130@400V
		28@415V	55.5@415V	84@415V	42/63/126@415V
Overload	%	<125%, long term			<110%, long term
		<130%, 10mins			<130%, 5 mins
		<150%, 1min			<150%, 1min
		>150%, 300ms			>150%, 300ms
Superior protection bypass line	N/A	Thermal-magnetic breaker, the capacity is 125% of rated current output. IEC60947-2 curve C			
Current rating of neutral cable	A	1.7×In			
Frequency	Hz	50/60			
Switch time (between bypass and inverter)	ms	Synchronized switch: ≤1ms			
Bypass voltage tolerance	% Vac	Upper limit: +10,+15,+20, +25, default: +15			
		Lower limit: -10, -20, -30 or -40, default:-20 (acceptable stable bypass voltage delay: 10s)			
Bypass frequency tolerance	%	±2.5, ±5, ±10 or ±20, default: ±10			
Synchronization-Window	Hz	Rated frequency±2Hz (selectable from ±0.5Hz~±5Hz)			
Note:					
<ol style="list-style-type: none"> 1. Factory setting is 400V. Commissioning engineers can set to 380V or 415V. 2. Commissioning engineers can set to 50Hz or 60Hz. For example, UPS is set to frequency inverter mode, and then bypass status will be neglected. 					

9.8 Efficiency

Table.9- 8: Efficiency, Air Exchange

Rated Efficiency (kVA)	Unit	10~90kVA
Efficiency		
Normal mode(dual conversion)	%	95max
ECO mode	%	99
Battery discharging efficiency (DC/AC) (battery at nominal voltage 480Vdc and full-rated linear load)		
Battery mode	%	94.5
Maximum air exchange	m ³ /min	4.5/power module, 3.02/bypass module

Appendix A Guide for Ordering and Selection of UPS Rack System

The UPS module can be divided into equipment cabinet and power module. For the cabinet lectotype please refer to the description as following:

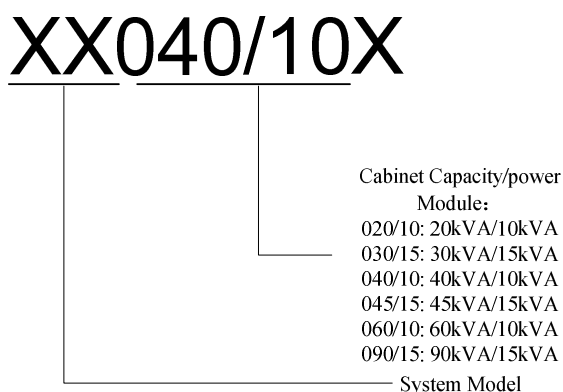

For single power module model please refers to the description as following:

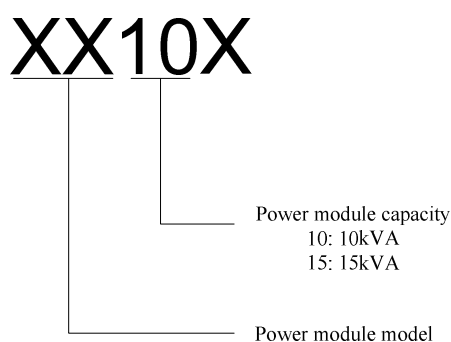

E.g.: the requirements of a plant room are given below:

The maximum power supply of the plant room is 40kVA; however, it is expected to be expanded to 90kVA in 3-5 years. The order symbol is:

1 set xx090/15X

6 set xx15X

Appendix B. Power Connection of Modular System

Fig.B-1 and Fig.B-2 illustrate the power connection of modular UPS in what are known as the 3/3, 3/1, 1/3 and 1/1 configuration.

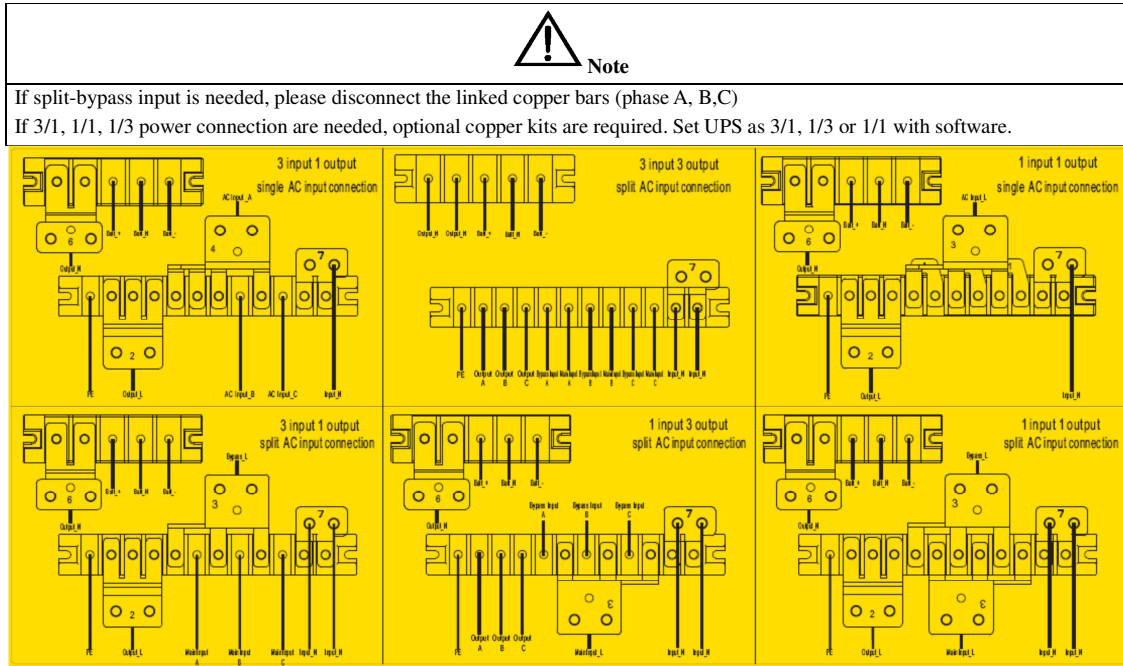

Fig.B- 1: Power Connection of 2 slots and 4 slots

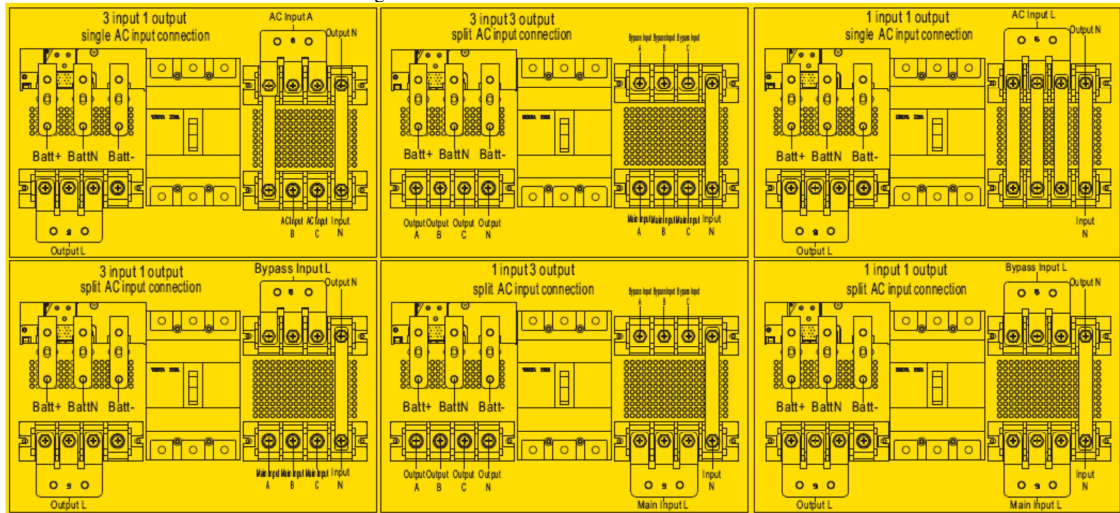

Fig.B- 2: Power Cables Connection of 6 slots cabinet

- **3 phases in, 3 phases out** (common input) is default setting. If need **3 phases in, 3 phases out (split bypass input)**, remove connecting copper bars between bypass and main input as Fig.B-1 and Fig.B-2.
- If need to set UPS as **3 phases in, 1 phase out**, connect cables as Fig.B-1 and Fig.B-2 as needed. Then set UPS with software as below:

Enter in "RateSetting", set output as **Out 3/1(1)** in Syscode Setting1, set input as **In 3/1(1)** in Syscode Setting 2, then confirm the set.

- If need to set UPS as **1 phase in, 1 phase out**, connect cables as Fig.B-1 and Fig.B-2 as needed. Then set UPS with software as below:

Enter in “RateSetting”, set **output** as **Out 3/1(1)** in **Syscode Setting1**, set **input** as **In 3/1(1)** in **Syscode Setting2**, then confirm the set.

- If need to set UPS as **1 phase in, 3 phases out (split bypass input)**, connect cables as Fig.B-1 and Fig.B-2 as needed. Then set UPS with software as below:

Enter in “RateSetting”, set **output** as **Out 3/1(1)** in **Syscode Setting1**, set **input** as **In 3/1(1)** in **Syscode Setting 2**, then confirm the set.



Note

If want to set **6 slots cabinet** as 1/1, 3/1, please make sure that connect output neutral cable to the input or bypass neutral connector.
 If want to set UPS as 1 phase in, 3 phases out but single input, must **forbid bypass function** via software.

Appendix C. Cold Start (Professional Version)

If professional version power modules are installed, users can start UPS from battery.

Press "Cold Start" button on the front panel of 1# power module, the power module starts on.

After two minutes, 1# power module inverter is on, LCD on cabinet is power on, then start on the remained power modules one by one.



Note

Make sure that start one power module firstly, start remained power modules when the LCD is power on.

AGKK14360

09/2021