

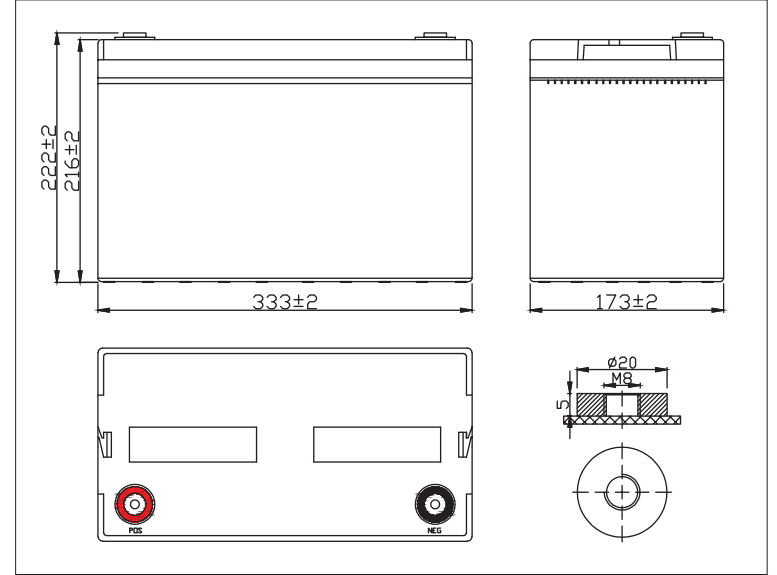

## GÖRÜNÜM VE ÖLÇÜLER

Birim: (mm) Terminal Tipi: (T3)



## ÖZELLİKLER

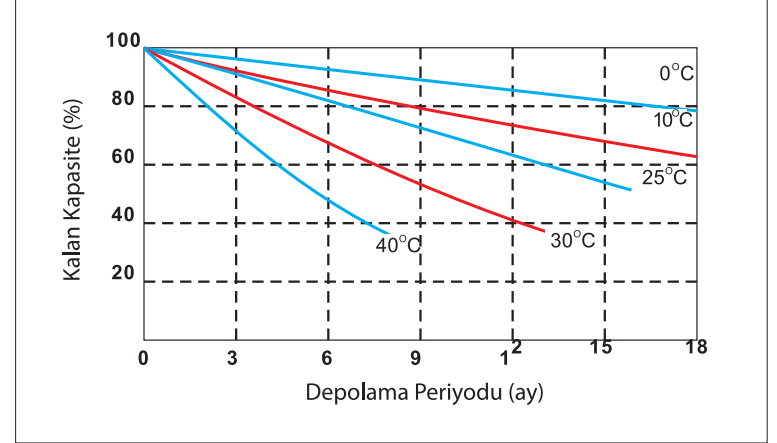

Nominal gerilim	12V	
Kapasite (25°C)	10 saat değeri (10A)	100Ah
Deşarj akım testi (25°C)	1 saat değeri (55A)	61Ah
	3 saat değeri (25A)	79Ah
İç direnç	Tamamen şarjlı akü 25°C	5mΩ
Sıcaklık ile kapasite değişimi	40°C	%104
	25°C	%100
	0°C	%83
	-15°C	%65
Depolama kapasite kaybı (25°C)	3 ay depolamada	%91
	6 ay depolamada	%82
	12 ay depolamada	%65
Şarj (Devamlı şarj)	Döngü (25°C)	İlk şarj akımı 30A'dan az Voltaj 14.5 ~ 14.9V
	Tampon (25°C)	Şarj voltajı 13.6 ~ 13.8V
Ağırlık (Yaklaşık)	30.5kg	

## DEPOLAMA KAPASİTE KAYBI

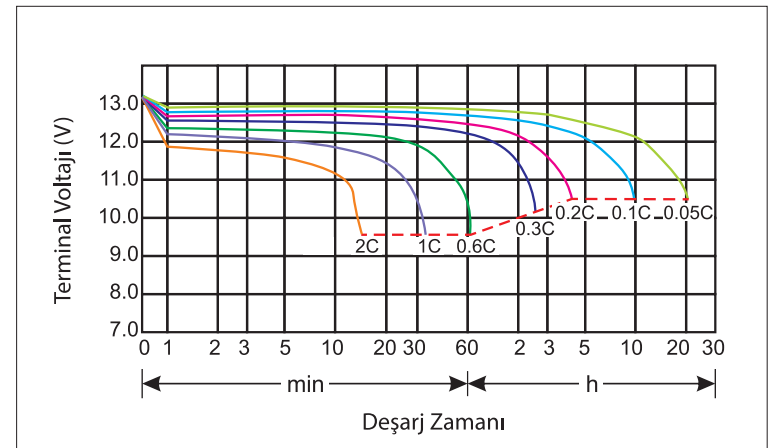

## DEŞARJ AKIMI 25°C



 <b>TR EN 60896-21/22</b>		 <b>MH26866</b>
 <b>ISO14001</b>	 <b>ISO9001</b>	 

## SABİT VOLTAJ ŞARJ KARAKTERİSTİKLERİ

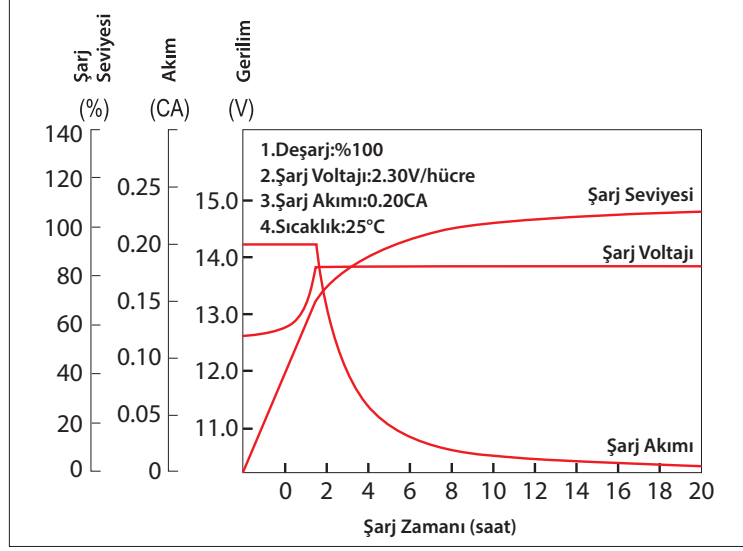

## ŞARJ-DEŞARJ DÖNGÜ SAYISI

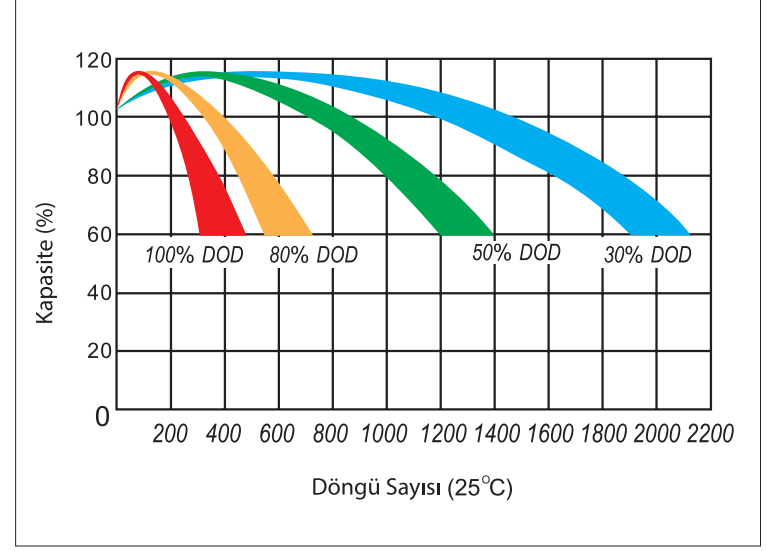

### SABİT AKIM DEŞARJ KARAKTERİSTİKLERİ (A, 25°C)

Çalışma süresi	10dk	15dk	30dk	60dk	2sa	3sa	5sa	8sa	10sa	20sa
9.60V	217.8	172.8	106.9	61.2	36.1	26.1	18.3	12.0	10.2	5.3
10.2V	206.9	165.6	103.0	58.6	35.6	25.7	18.0	11.9	10.1	5.2
10.5V	196.8	160.2	100.0	57.2	35.3	25.5	17.8	11.8	10.0	5.2
10.8V	175.6	155.8	97.8	56.4	34.9	25.2	17.6	11.7	10.0	5.1

### SABİT GÜÇ DEŞARJ KARAKTERİSTİKLERİ (Watts/Block, 25°C)

Çalışma süresi	10dk	15dk	30dk	60dk	2sa	3sa	5sa	8sa	10sa	20sa
9.60V	2352.2	1902.8	1199.9	733.6	418.8	306.9	216.8	144.5	121.8	64.3
10.2V	2234.4	1826.6	1155.3	703.9	412.8	302.9	212.9	143.9	120.8	63.6
10.5V	2204.2	1794.2	1149.9	657.8	408.9	300.0	209.9	143.6	119.8	63.4
10.8V	1984.3	1745.0	1115.1	643.0	404.9	297.0	207.9	142.6	118.2	63.0

### FARKLI SICAKLIKLARDA KAPASİTE ORANLARI

Akü tipi	-20°C	-10°C	0°C	5°C	10°C	20°C	25°C	30°C	40°C	45°C
Jel Akü 12V	%50	%70	%83	%85	%90	%98	%100	%102	%104	%105